



www.CrossCreekTractor.com

Call Us: 1 (800) 462-7335

**AFTERMARKET TRACTOR PARTS
FOR
MASSEY
FERGUSON**

**ALL PARTS LISTED ARE AFTERMARKET REPLACEMENT PARTS AND ARE NOT
PRODUCED BY THE ORIGINAL EQUIPMENT MANUFACTURER**



Contents - Massey Ferguson

Clutch	221	Mufflers.....	207
Cooling	217	PTO	229
Electrical.....	213	Rear Axle & Brakes	231
Engine, Balancers	202	Rear Axle & Differential	230
Engine, Crankshafts	199	Seats	261
Engine, Crankshaft Pulleys	202	Sheet Metal	256
Engine, Cylinder Blocks.....	200	Shop Manuals.....	264
Engine, Cylinder Heads.....	200	Steering, Control Valves	242
Engine, Flywheels	202	Steering, P/S Cylinders	239
Engine, Misc.....	203	Steering, P/S Kits	241
Engine, Overhaul Kits.....	189	Steering, P/S Cylinder Parts.....	240
Engine, Shortblocks.....	201	Steering, P/S Pumps	238
Front Axle, Axle Parts	244	Steering, Sector Parts	236
Front Axle, Hubs.....	245	Steering, Steering Sectors.....	237
Front Axle, Steering Arms.....	245	Steering, Tie Rod Ends.....	233
Front Axle, Supports	244	Transmission	224
Fuel.....	207	Transmission, Instant Reverse	228
Hitch	254	Wheels & Rims	262
Hydraulics, Hydraulic Pumps.....	246		
Hydraulics, Lift Top Parts.....	251		
Hydraulics, Pump Parts.....	248		
Hydraulics, Remote Kits	254		
Manifolds	206		



ENGINE, OVERHAUL KITS

Massey Ferguson

MF 35, 50, 202, 203, 204, 205
A3.152 Indirect Injection (Flat Top Pistons)

EOKMFA3152A

Engine Overhaul Kit
 Contains Pistons, Sleeves,
 Rings, Piston Pin Bushings,
 Complete Gasket Set, Front and Rear
 Crankshaft Seals

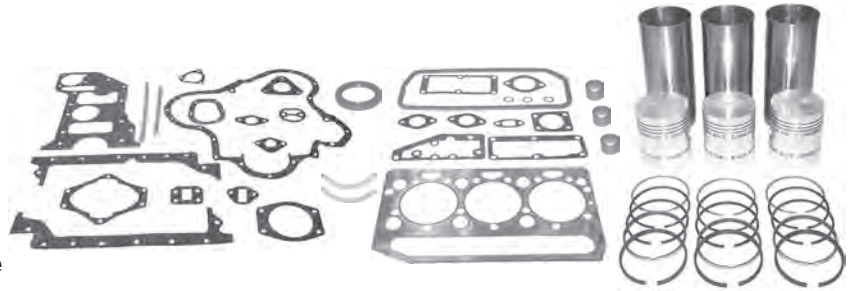

Sleeves Have 0.150" Thick Top Flange
Please Confirm Before Ordering
(Order Bearings Separately)

Order Individual Parts Below

734460M91

Piston, Individual

745818M91

Ring Set, Individual

739043M1

Sleeve, Individual



737070M91

Rod Bearing Set, STD

737071M91

Rod Bearing Set, .010

737072M91

Rod Bearing Set, .020

737073M91

Rod Bearing Set, .030



746156M91

Main Bearing Set, STD

746157M91

Main Bearing Set, .010

746158M91

Main Bearing Set, .020

746159M91

Main Bearing Set, .030



3113721121

Thrust Washer Set



747166M91

Top Gasket Set

747187M91

Bottom Gasket Set

1447689M1

Front Crankshaft Seal

735866M1

Rear Crankshaft Seal (Priced as Pair)

740407M1

Connecting Rod Bushing

736513M91

Oil Pump

731151M1

Intake Valve

731152M1

Exhaust Valve

732445M1

Valve Guide

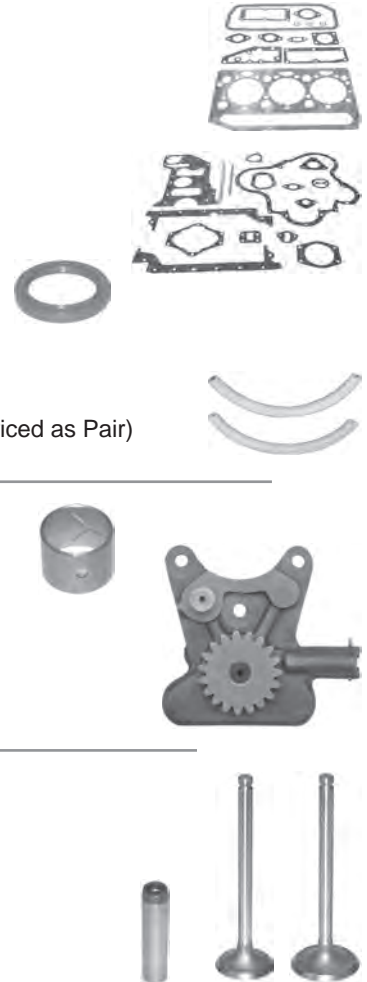



Massey Ferguson

ENGINE, OVERHAUL KITS

**MF 135, 150, 20, 2135, 230, 235, 245
AD3.152 Direct Injection
5 Ring Piston, Rope Seal Crankshaft**

EOKMFAD3152A

Engine Overhaul Kit
Contains Pistons, Sleeves,
Rings, Piston Pin Bushings,
Complete Gasket Set, Front and Rear
Crankshaft Seals

(Order Bearings Separately)

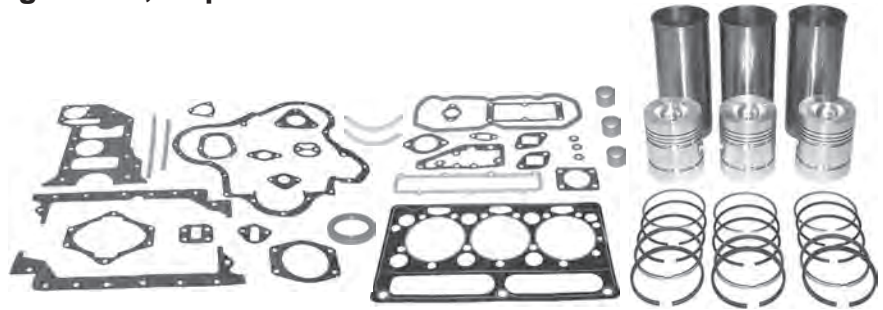

Order Individual Parts Below

743824M91

Piston, Individual

745819M91

Ring Set, Individual

739043M1

Sleeve, Individual



737070M91

Rod Bearing Set, STD

737071M91

Rod Bearing Set, .010

737072M91

Rod Bearing Set, .020

737073M91

Rod Bearing Set, .030



746156M91

Main Bearing Set, STD

746157M91

Main Bearing Set, .010

746158M91

Main Bearing Set, .020

746159M91

Main Bearing Set, .030



3113721121

Thrust Washer Set



748008M91

Top Gasket Set

747187M91

Bottom Gasket Set

1447689M1

Front Crankshaft Seal

735866M1

Rear Crankshaft Seal (Priced as Pair)

740407M1

Connecting Rod Bushing

736513M91

Oil Pump

732811M1

Intake Valve

737640M1

Exhaust Valve

732445M1

Valve Guide

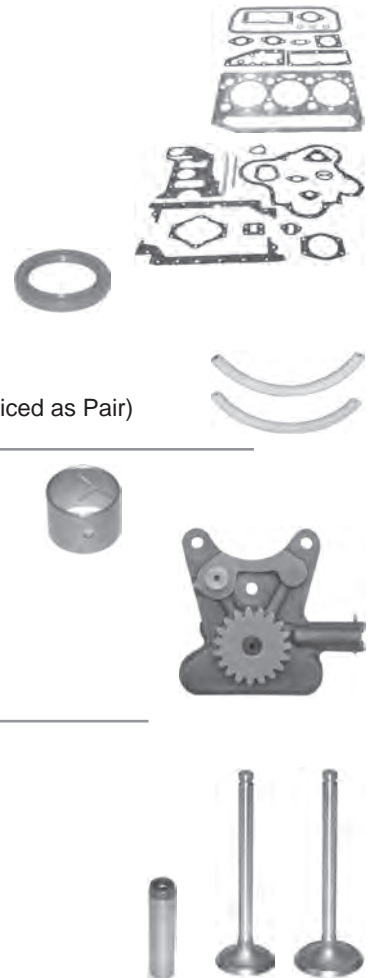



ENGINE, OVERHAUL KITS

Massey Ferguson

**MF 135, 150, 20, 2135, 230, 235, 245, 20C, 30B
AD3.152 Direct Injection
5 Ring Piston, Lip Seal Crankshaft**

EOKMFAD3152B

Engine Overhaul Kit
Contains Pistons, Sleeves,
Rings, Piston Pin Bushings,
Complete Gasket Set, Front and Rear
Crankshaft Seals

(Order Bearings Separately)

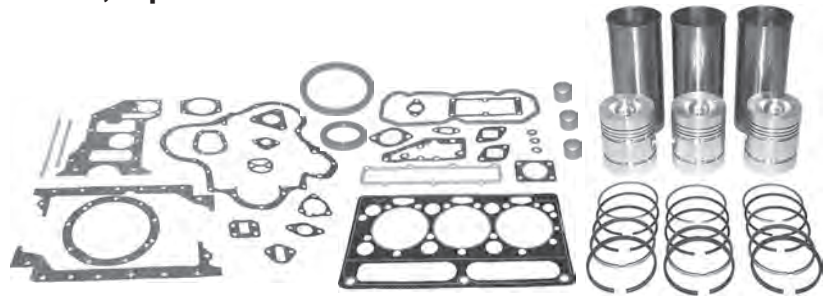

Order Individual Parts Below

743824M91

Piston, Individual

745819M91

Ring Set, Individual

739043M1

Sleeve, Individual



737070M91

Rod Bearing Set, STD

737071M91

Rod Bearing Set, .010

737072M91

Rod Bearing Set, .020

737073M91

Rod Bearing Set, .030



746156M91

Main Bearing Set, STD

746157M91

Main Bearing Set, .010

746158M91

Main Bearing Set, .020

746159M91

Main Bearing Set, .030



3113721121

Thrust Washer Set



748008M91

Top Gasket Set

747186M91

Bottom Gasket Set

1447689M1

Front Crankshaft Seal

1447691M1

Rear Crankshaft Seal

740407M1

Connecting Rod Bushing

736513M91

Oil Pump

732811M1

Intake Valve

737640M1

Exhaust Valve

732445M1

Valve Guide

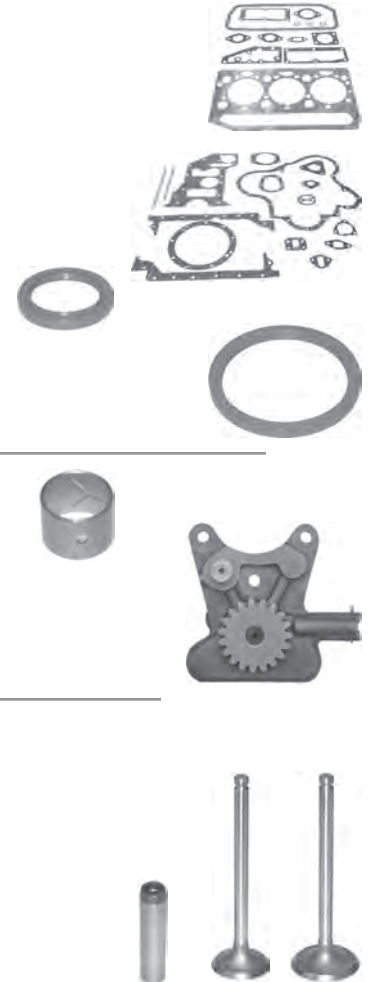



Massey Ferguson

ENGINE, OVERHAUL KITS

**MF 230, 235, 245, 240, 250
AD3.152 Direct Injection
4 Ring Piston, Lip Seal Crankshaft**

EOKMFAD3152C

Engine Overhaul Kit
Contains Pistons, Sleeves,
Rings, Piston Pin Bushings,
Complete Gasket Set, Front and Rear
Crankshaft Seals

(Order Bearings Separately)

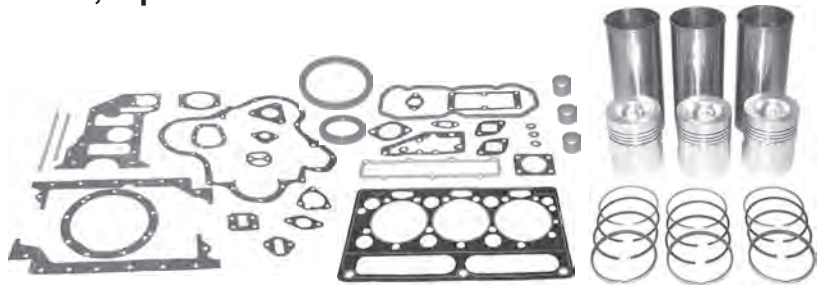

Order Individual Parts Below

742621M91

Piston, Individual

745826M91

Ring Set, Individual

739043M1

Sleeve, Individual



737070M91

Rod Bearing Set, STD

737071M91

Rod Bearing Set, .010

737072M91

Rod Bearing Set, .020

737073M91

Rod Bearing Set, .030



746156M91

Main Bearing Set, STD

746157M91

Main Bearing Set, .010

746158M91

Main Bearing Set, .020

746159M91

Main Bearing Set, .030



3113721121

Thrust Washer Set



748008M91

Top Gasket Set

747186M91

Bottom Gasket Set

1447689M1

Front Crankshaft Seal

1447691M1

Rear Crankshaft Seal

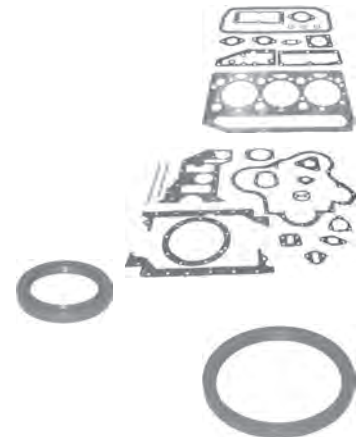

740407M1

Connecting Rod Bushing

736513M91

Oil Pump

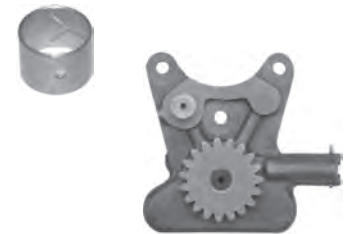

731151M1

Intake Valve

731152M1

Exhaust Valve

732445M1

Valve Guide





ENGINE, OVERHAUL KITS

Massey Ferguson

MF 65, 302, 304

A4.203 Indirect Injection (Flat Top Pistons)

EOKMFA4203A

Engine Overhaul Kit
 Contains Pistons, Sleeves,
 Rings, Piston Pin Bushings,
 Complete Gasket Set, Front and Rear
 Crankshaft Seals

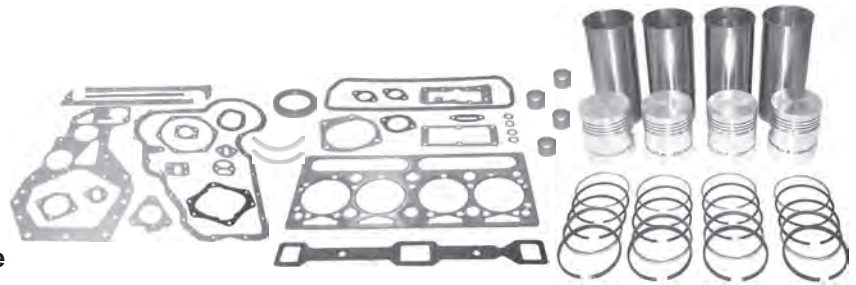

**Sleeves Have 0.150" Thick Top Flange
 Please Confirm Before Ordering
 (Order Bearings Separately)**

Order Individual Parts Below

734460M91
 Piston, Individual

745818M91
 Ring Set, Individual

739043M1
 Sleeve, Individual



737066M91
 Rod Bearing Set, STD

737067M91
 Rod Bearing Set, .010

737068M91
 Rod Bearing Set, .020

737069M91
 Rod Bearing Set, .030



745405M91
 Main Bearing Set, STD

745406M91
 Main Bearing Set, .010

745407M91
 Main Bearing Set, .020

745408M91
 Main Bearing Set, .030



3113721121
 Thrust Washer Set



746051M91
 Top Gasket Set

743029M91
 Bottom Gasket Set

1447689M1
 Front Crankshaft Seal

735866M1
 Rear Crankshaft Seal (Priced as Pair)

740407M1
 Connecting Rod Bushing

3637470M91
 Oil Pump

731151M1
 Intake Valve

731152M1
 Exhaust Valve

732445M1
 Valve Guide



Massey Ferguson

ENGINE, OVERHAUL KITS

**MF 65, 165, 30, 40, 50, 302, 304, 356
AD4.203 Direct Injection**

EOKMFAD4203A

Engine Overhaul Kit
Contains Pistons, Sleeves,
Rings, Piston Pin Bushings,
Complete Gasket Set, Front
and Rear Crankshaft Seals

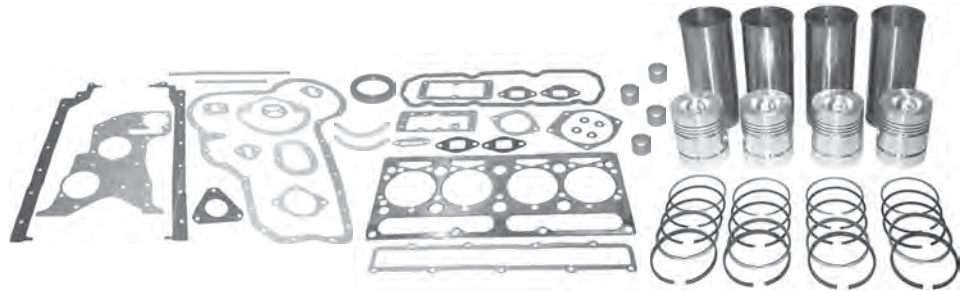

(Order Bearings Separately)

Order Individual Parts Below

743824M91

Piston, Individual

745819M91

Ring Set, Individual

739043M1

Sleeve, Individual



737066M91

Rod Bearing Set, STD

737067M91

Rod Bearing Set, .010

737068M91

Rod Bearing Set, .020

737069M91

Rod Bearing Set, .030



745405M91

Main Bearing Set, STD

745406M91

Main Bearing Set, .010

745407M91

Main Bearing Set, .020

745408M91

Main Bearing Set, .030



3113721121

Thrust Washer Set



735349M91

Top Gasket Set



735350M91

Bottom Gasket Set



1447689M1

Front Crankshaft Seal



735866M1

Rear Crankshaft Seal (Priced as Pair)



740407M1

Connecting Rod Bushing



3637470M91

Oil Pump



732811M1

Intake Valve

737640M1

Exhaust Valve



732445M1

Valve Guide



ENGINE, OVERHAUL KITS

Massey Ferguson

MF 175, 180, 255, 265, 261, 270, 31, 50C, 50D, 50E, 50F, 60, 6500

AD4.236 Direct Injection
with 4.065 O. D. Sleeve

EOKMFAD4236A

Engine Overhaul Kit
Contains Pistons, Sleeves,
Rings, Piston Pin Bushings,
Complete Gasket Set,
Front and Rear
Crankshaft Seals

Contains
Rope and Lip Seals

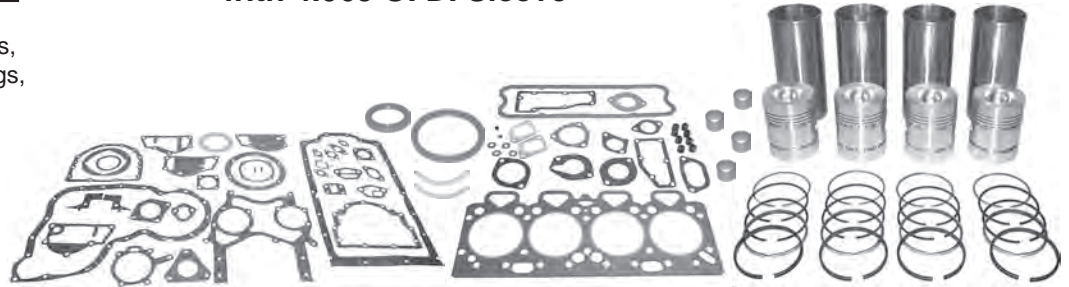

(Order Bearings Separately)

Order Individual Parts Below

743110M91
Piston, Individual



745760M91
Ring Set, Individual



736507M1
Sleeve, Individual 4.065" O.D.

736950M91
Rod Bearing Set, STD

736951M91
Rod Bearing Set, .010

736952M91
Rod Bearing Set, .020

736953M92
Rod Bearing Set, .030



735168M91
Main Bearing Set, STD

735169M91
Main Bearing Set, .010

735170M91
Main Bearing Set, .020

735171M91
Main Bearing Set, .030



3113755161
Thrust Washer Set



3638661M91
Top Gasket Set



747191M91
Bottom Gasket Set



1446853M1
Front Crankshaft Seal



735942M1
Rear Crankshaft Seal (Rope Type)
(Priced as Pair)



1447691M1
Rear Crankshaft Seal
(Lip Type)



733767M1
Connecting Rod Bushing



743194M1
Oil Pump for 4 Bolt Balancer



3637489M91
Oil Pump for 6 Bolt Balancer



739027M1
Intake Valve

733818M1
Exhaust Valve

736297M1
Valve Guide





Call Us: 1 (800) 462-7335

Massey Ferguson

ENGINE, OVERHAUL KITS

MF 175, 180, 255, 265, 261, 270, 31, 50C, 50D, 50E, 50F, 60, 6500

AD4.236 Direct Injection
with 4.105 O. D. Sleeve

EOKMFAD4236B

Engine Overhaul Kit
Contains Pistons, Sleeves,
Rings, Piston Pin Bushings,
Complete Gasket Set, Front and Rear
Crankshaft Seals

Contains Rope
and Lip Seals



(Order Bearings Separately)

Order Individual Parts Below

743110M91

Piston, Individual

745760M91

Ring Set, Individual

744131M1

Sleeve, Individual 4.105 O.D.



736950M91

Rod Bearing Set, STD

736951M91

Rod Bearing Set, .010

736952M91

Rod Bearing Set, .020

736953M92

Rod Bearing Set, .030



735168M91

Main Bearing Set, STD

735169M91

Main Bearing Set, .010

735170M91

Main Bearing Set, .020

735171M91

Main Bearing Set, .030



3113755161

Thrust Washer Set



3638661M91

Top Gasket Set

747191M91

Bottom Gasket Set

1446853M1

Front Crankshaft Seal

735942M1

Rear Crankshaft Seal (Rope Type) (Priced
as Pair)

1447691M1

Rear Crankshaft Seal
(Lip Type)

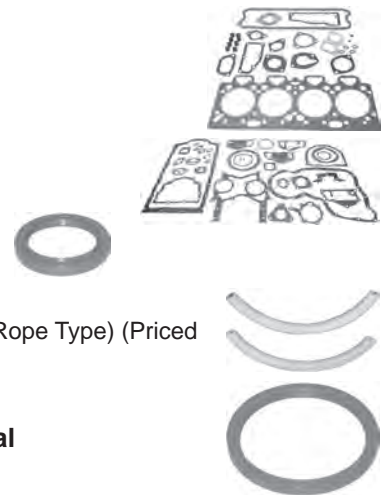

733767M1

Connecting Rod Bushing

743194M1

Oil Pump for 4 Bolt Balancer

3637489M91

Oil Pump for 6 Bolt Balancer

739027M1

Intake Valve

733818M1

Exhaust Valve

736297M1

Valve Guide





ENGINE, OVERHAUL KITS

Massey Ferguson

**MF 275, 283, 290, 690, 50H, 60H
AD4.248 Direct Injection
4 Ring Piston**

EOKMFAD4248A

Engine Overhaul Kit
Contains Pistons, Sleeves,
Rings, Piston Pin Bushings,
Complete Gasket Set, Front and Rear
Crankshaft Seals

Contains Rope
and Lip Seals

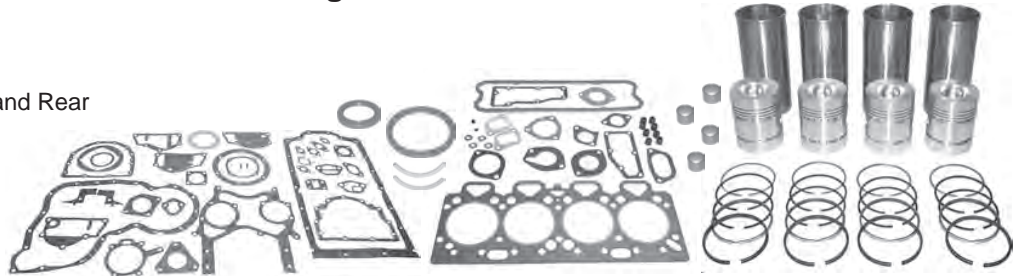

(Order Bearings Separately)

Order Individual Parts Below

740821M91
Piston, Individual

740535M91
Ring Set, Individual

742466M1
Sleeve, Individual



736950M91
Rod Bearing Set, STD

736951M91
Rod Bearing Set, .010

736952M91
Rod Bearing Set, .020

736953M92
Rod Bearing Set, .030



735168M91
Main Bearing Set, STD

735169M91
Main Bearing Set, .010

735170M91
Main Bearing Set, .020

735171M91
Main Bearing Set, .030



3113755161
Thrust Washer Set



3638661M91
Top Gasket Set

747191M91
Bottom Gasket Set

1446853M1
Front Crankshaft Seal

735942M1
Rear Crankshaft Seal (Rope Type) (Priced
as Pair)

1447691M1
Rear Crankshaft Seal
(Lip Type)

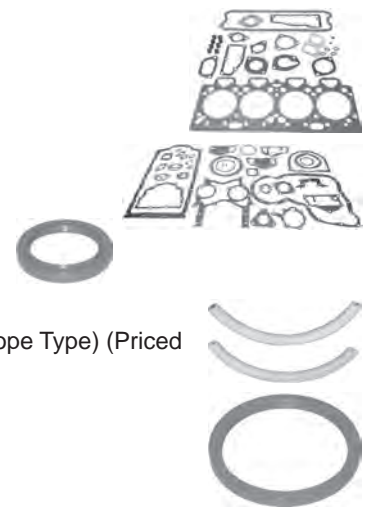

733767M1
Connecting Rod Bushing

743194M1
Oil Pump for 4 Bolt Balancer

3637489M91
Oil Pump for 6 Bolt Balancer

739027M1
Intake Valve

733818M1
Exhaust Valve

736297M1
Valve Guide





Massey Ferguson

ENGINE, OVERHAUL KITS

MF 283, 290, 294, 383, 390, 394, 690, 3050, 3060, 50E, 50H

AD4.248 Direct Injection

3 Ring Piston

EOKMFAD4248B

Engine Overhaul Kit

Contains Pistons, Sleeves,
Rings, Piston Pin Bushings,
Complete Gasket Set, Front and Rear
Crankshaft Seals

Contains Rope
and Lip Seals

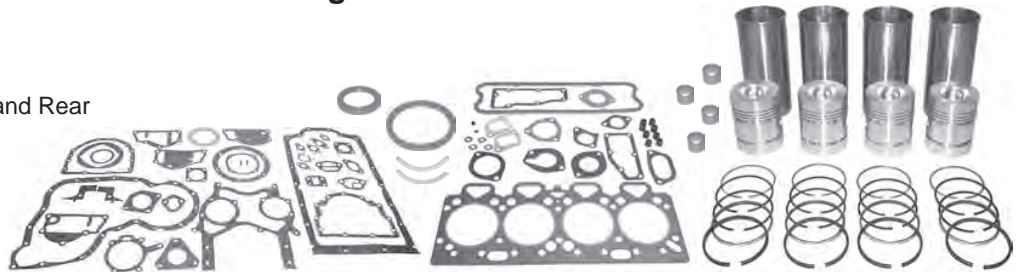

(Order Bearings Separately)

Order Individual Parts Below

747050M91

Piston, Individual

747428M91

Ring Set, Individual

742466M1

Sleeve, Individual



736950M91

Rod Bearing Set, STD

736951M91

Rod Bearing Set, .010

736952M91

Rod Bearing Set, .020

736953M92

Rod Bearing Set, .030



735168M91

Main Bearing Set, STD

735169M91

Main Bearing Set, .010

735170M91

Main Bearing Set, .020

735171M91

Main Bearing Set, .030



3113755161

Thrust Washer Set



3638661M91

Top Gasket Set

747191M91

Bottom Gasket Set

1446853M1

Front Crankshaft Seal

735942M1

Rear Crankshaft Seal (Rope Type) (Priced as Pair)

1447691M1

Rear Crankshaft Seal (Lip Type)

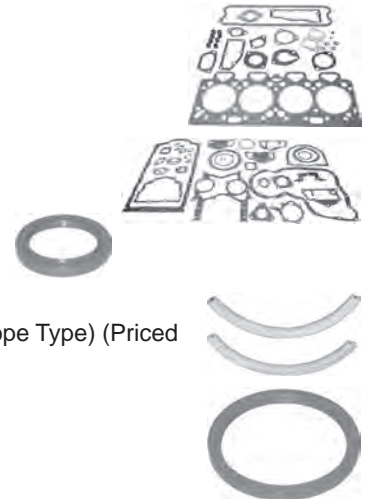

733767M1

Connecting Rod Bushing

743194M1

Oil Pump for 4 Bolt Balancer

3637489M91

Oil Pump for 6 Bolt Balancer

739027M1

Intake Valve

733818M1

Exhaust Valve

736297M1

Valve Guide





ENGINE, CRANKSHAFTS

Massey Ferguson

CRANKSHAFT39

Replaces 1750280M91
Crankshaft, Continental
Z120



Fits TO20

CRANKSHAFT18

Replaces 736187M91, 742742M91
Crankshaft, Perkins 4.203
4 Cylinder, Keyed Nose,
Rope Seal



Fits 65, 165, 40 Ind., 3165

CRANKSHAFT38

Replaces 1750169M1
Crankshaft, Continental
Z129, Z134



Fits TO30, TO35, F40, 35, 50, 202, 203, 204, 205

CRANKSHAFT14

Crankshaft, Perkins 4.236
4 Cylinder Splined Nose,
Rope Seal



Fits 175, 180, 31

CRANKSHAFT01

Replaces 3637454M1, 736532M1, 084402
Crankshaft, Perkins 3 Cylinder
A3.152 or AD3.152 with
2-Piece Rope Seal



Fits 35, 50, 135, 150, 202, 203, 204, 2020, 2135

CRANKSHAFT12

Replaces 746382M91, ZZ90122
Crankshaft, Perkins AD4.236, AD4.248
4 Cylinder Splined Nose, Lip Seal
1 Bolt Snout



Fits 255, 265, 275, 270,
282, 283

CRANKSHAFT49

Replaces 3637402M91
Crankshaft, Perkins AD4.236, AD4.248
4 Cylinder Lip Seal, Spline Nose
3 Bolt Snout



Fits 282, 283, 290, 294-4,
383, 390, 390T, 393, 398,
670, 690, 3050, 3060,
3065, 3070, 50C, 50D, 50E, 50F, 50H, 60, 6500

CRANKSHAFT02

Replaces 3637410M1, 742827M1, U5BG0027
Crankshaft, Perkins 3 Cylinder
AD3.152 with 1-piece
Lip Seal



Fits 135, 150, 230, 235, 245, 253, 360, 362, 270, 282, 283,
20, 2135, 20C, 30B, 40B

CRANKSHAFT11

Replaces 744925M91, 68007
Crankshaft, Perkins AD6.354.4
6 Cylinder
Keyed Nose,
Lip Seal



Fits 2675, 2705, 750, 760, 850, 860 Combine

CRANKSHAFT03

Replaces 742344M91, 94455
Crankshaft, Perkins 4.203
4 Cylinder, Keyed
Nose, Lip Seal



Fits 255

CRANKSHAFT29

Crankshaft, Perkins 4.203
Splined Nose, Lip Seal



Fits Perkins Industrial Applications

Massey Ferguson

ENGINE, CYLINDER HEADS, CYLINDER BLOCKS

3638321M91

Replaces 731781M91, 735093M91
Cylinder Head A3.152
Regular Injection



Fits 35, 50, 202, 203, 204, 205

3637770M91 ~~X~~

Replaces 737422M91
Engine Block A3.152, AD3.152
Rope Style Crankshaft Seal
(with Sleeves)



Fits 35, 50, 135, 150, 20, 2135, 202, 203, 204, 205, 20, 2135

3637389M91

Replaces 734201M91
Cylinder Head AD3.152
Direct Injection



Fits 135, 150, 230, 235, 245, 231, 240, 250, 20, 2135, 20C, 30B, 20D, 30E, 40E

3637484M91

Replaces 747298M91, 742781M91, 747298M91, 37111570
Engine Block AD3.152
Lip Style Crankshaft Seal
4-Bolt Fuel Pump Mount
Lip Seal (with Sleeves)



Fits 135, 150, 230, 235, 245, 231, 240, 250, 253, 360, 362, 202, 203, 204, 205, 20, 2135, 20C, 30B, 40B, 20D, 30E, 40E

3637485M91

Replaces 733309M91, 731682M91
Cylinder Head A4.203
Regular Injection



Fits MF 65, 302, 304

743069M91

Replaces 743070M91
Engine Block AD4.236
Lip Seal (with Sleeves)



Fits 175, 180, 255, 265, 275, 253, 360, 362, 270, 282, 283, 375, 383, 390, 390T, 398, 399

3637384M91

Replaces 737701M91
Cylinder Head AD4.203
Direct Injection



Fits 65, 165, 30, 3165, 302, 304, 40, 40B

3641082M91

Replaces 3637379M91, 3637491M91
Engine Block AD4.248
Lip Seal (with Sleeves)



Fits 175, 180, 255, 265, 275, 253, 360, 362, 270, 282, 283, 375, 383, 390, 390T, 398, 399



ENGINE, SHORTBLOCKS

Massey Ferguson

SHORTBLOCK01

**Replaces 1896371M91,
4222503M91, 1896318M91,
4222504M91**

Shortblock AD3.152
3 Cylinder, Lip Seal

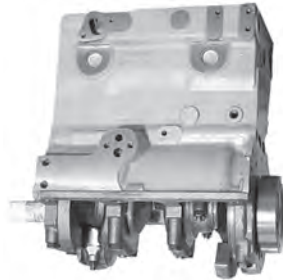

Fits 135, 150, 230, 235, 245, 231, 240, 250, 253, 360, 362,
20, 2135, 20C, 30B, 40B, 20D, 30E, 40E

SHORTBLOCK02

**Replaces 1896341M91,
3641151M91**

Shortblock AD4.236
4 Cylinder, Lip Seal
(Front Mount Balancer)

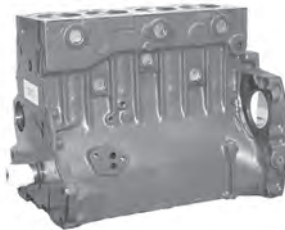

Fits 175, 180, 255, 265, 275, 253, 360, 362, 270, 282, 283,
375, 383, 390, 398, 399

SHORTBLOCK03

**Replaces 1896326M91,
3641093M91**

Shortblock AD4.248
4 Cylinder, Lip Seal

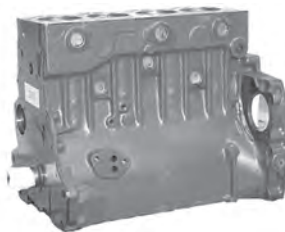

Fits 175, 180, 255, 265, 275, 253, 360, 362, 270, 282, 283,
375, 383, 390, 390T, 398, 399

**All Shortblocks Consist of Block, Crankshaft,
Connecting Rods, Pistons, Rings, and Sleeves**

Camshafts are NOT Included

Massey Ferguson

ENGINE, BALANCERS, FLYWHEELS, CRANKSHAFT PULLEYS

743206M91

Balancer Assy
Front Mount
(4 Bolt Mount)
AD4.236
AD4.248



Fits 175, 180, 255, 265, 275, 270, 282, 283

740681M91

Replaces 41115004
Flywheel for 12" Clutch

Fits 231, 240, 250, 263, 360,
20D, 20E, 30E, 30H, 40E



742106M91

Replaces 41117084
Flywheel for 12" Clutch

Fits 261, 270, 271, 275, 282, 283, 290, 365, 375, 383, 390,
670, 690, 50E

3637352M1

Balancer Assy
Mid Mount
(6 Bolt Mount)
AD4.236
AD4.248



Fits 270, 282, 283, 375, 383, 390, 390T, 398, 399

734627M1

Replaces 31143733
Crankshaft Pulley
A3.152, AD3.152,
AG3.152



Fits 35, 50, 135, 150, 230, 235, 245, 240, 250, 253, 263,
20, 2135, 20C, 30B

731988M1

Flywheel Ring Gear
122 Teeth

Fits 285, 298, 1080, 1085,
1100, 1130, 1105, 1135,
698, Super 90



731008M1

Flywheel Ring Gear
115 Teeth

Fits 35, 50, 65, 135, 150, 165, 175, 180, 230, 235, 245,
255, 265, 275, 231, 240, 250, 253, 360, 362, 270, 282,
283, 375, 383, 390, 390T, 398, 399, 202, 203, 204, 205,
302, 304, 20, 2135, 20C, 30B, 40B, 20D, 30E, 40E, 30,
31, 40, 3165

734562M1

Crankshaft Pulley
A4.203 & AD4.203
3 Bolt



Fits 65, 165, 255, 270, 282, 283

731192M1

Flywheel Tab Washer

Fits 35, 50, 65, 135, 150, 165, 175, 180, 230, 235, 245,
255, 265, 275, 231, 240, 250, 253, 360, 362, 270, 282,
283, 375, 383, 390, 390T, 398, 399, 202, 203, 204, 205,
302, 304, 20, 2135, 20C, 30B, 40B, 20D, 30E, 40E, 30,
31, 40, 3165



734812M1

Crankshaft Pulley
AD4.236 & AD4.248
4 Bolt



Fits 175, 180, 255, 265, 275, 270, 282, 283

ENGINE, MISC

Massey Ferguson

731117M91

Dipstick
AD3.152, AD4.203 Engines

Fits 35, 50, 65, 135, 150, 230, 235, 245, 231, 240, 250, 202, 203, 204, 205, 20, 2135, 20C, 30B, 40B, 20D, 30E, 40E, 165, 3165, 40, 50, 50A, 250, 253, 255



735129M91

Dipstick
AD4.236, AD4.248 Engines

Fits 175, 180, 255, 265, 275, 253, 360, 362, 270, 282, 283, 375, 383, 390, 390T, 398, 399

741922M1

Spin on Oil Filter Base
A3.152, AD3.152, A4.203, AD4.203



731124M1

Oil Filter Base Gasket
A3.152, AD3.152, A4.203, AD4.203



Fits 35, 50, 65, 135, 150, 165, 230, 235, 245, 231, 240, 250, 20, 2135, 20C, 30B, 40B, 20D, 30E, 40E

741614M1

Spin on Oil Filter Base
AD4.236 & AD4.248



736322M1

Oil Filter Base Gasket
AD4.236 & AD4.248



Fits 175, 180, 255, 265, 275, 270, 282, 283

1447082M1

Spin on Oil Filter



Fits 35, 50, 65, 135, 150, 165, 230, 235, 245, 231, 240, 250, 20, 2135, 20C, 30B, 40B, 20D, 30E, 40E, 175, 180, 255, 265, 275, 270, 282, 283

529737M91

Replaces 529737M1

Governer
For Tractors With Z120, Z129, Z134, and Z145 Continental Engines



Fits TO20, TO30, TO35, 30, 35, 40, 50, 135, 150, 230, 235, 245, 2135, 2200, 2500, 20C, 30B

ROCKERARM01

Rockerarm Assy
Z120, Z129, Z134, Z145 4 Cylinder Gas Engines



Fits TO20, TO30, TO35, 35, 50, 135, 150, 230, 235, 245, 202, 203, 204, 205, 20, 2135, 20C

636762M1

Tachometer Drive
Housing Seal



Fits 35, 50, 65, 135, 135UK, 150, 165, 165UK, 2135, 3165, 20, 20C, 20D, 30, 30B, 30D, 30E, 40, 40B, 50, 50A, 200 Series, 205, 205-4, 230, 231, 235, 240, 240S, 240P, 245, 250, 255, 302, 304, 2200, 2500 Forklift, 4500 Forklift, Allis Chalmers 160

731209M1

Tachometer Housing
Gasket
For 3 Cylinder Perkins
Engines



Fits 35, 50, 135, 150, 230, 235, 245, 240, 250, 202, 203, 204, 205, 20, 2135, 20C, 20D, 20E, 20F, 30B, 30D, 30E, 30H, 40, 40E

747454M1

Replaces 737211M91,
733988M91

Front Timing Cover
AD3.152
3 Cylinder



Fits 35, 50, 135, 150, 230, 235, 245, 231, 240, 250, 253, 360, 362, 202, 203, 204, 205, 20, 2135, 20C, 30B, 40B, 20D, 30E, 40E

Massey Ferguson

ENGINE, MISC

739477M1

Replaces 733987M91
Rear Timing Cover
AD3.152



Fits 35, 50, 135, 150, 230, 235, 245, 231, 240, 250, 253, 360, 362, 202, 203, 204, 205, 20, 2135, 20C, 30B, 40B, 20D, 30E, 40E

741401M1

Engine Backing Plate
AD3.152
with Lip Seal Crankshaft



Fits 135, 150, 230, 235, 245, 231, 240, 250, 253, 360, 362, 202, 203, 204, 205, 20, 2135, 20C, 30B, 40B, 20D, 30E, 40E

740235M91

Rear Crankshaft Seal Retainer
For Rope Type Seal



Fits 35, 50, 135, 150, 202, 203, 204, 205, 20, 2135

3637439M91

Casting Number 0210007
Connecting Rod
For Indirect Injection Engines



Fits 35, 50, 65, 202, 203, 204, 205, 356, 302, 304

747383M91

Replaces 37424611, 741969M1
Rear Crankshaft Seal Retainer
For Lip Type Seal



Fits 135, 150, 230, 235, 245, 231, 240, 250, 253, 360, 362, 20, 2135, 20C, 30B, 40B, 20D, 30E, 40E

3637392M91

Casting Number 31337220
Connecting Rod
For Direct Injection Engines



Fits 65, 135, 150, 165, 230, 235, 245, 255, 231, 240, 250, 253, 360, 302, 304, 20, 2135, 20C, 30B, 40B, 20D, 30E, 40E, 30, 31, 40, 3165

741600M1

Oil Pan
AD3.152
Lip Seal Style



Fits 135, 150, 230, 235, 245, 231, 240, 250, 253, 360, 362, 202, 203, 204, 205, 20, 2135, 20C, 30B, 40B, 20D, 30E, 40E

3637034M91

Replaces 736595M91, 738713M91, 747007M91, 84920
Connecting Rod
For 4.236, 4.248, 6.354 Engines



Fits 175, 178, 180, 185, 188, 255, 261, 265, 270, 275, 282, 283, 290, 294, 362, 365, 374, 375, 383, 384, 390, 394, 396, 399, 699, 1100, 1130, 2640, 2675, 3050, 3060, 3090, 3095, 3120, 3505, 4225, 4235, 4260, 4270, 6170, 31, 50C, 50D, 50E, 50H, 60, 60H, 6500



ENGINE, MISC

Massey Ferguson

731228M1

Crankshaft Gear



Fits 35, 50, 135, 150, 230, 235, 245, 240, 250, 231, 360, 364, 253, 263, 451, 202, 203, 204, 205, 20, 2135, 20C, 20D, 20E, 20F, 30B, 30D, 30E, 30H, 40, 40E

733644M1

Replaces 733645M1,
31731515, 21731516,
Weight Washer



Fits 35, 50, 135, 150, 230, 235, 245, 231, 240, 250, 253, 360, 362, 202, 203, 204, 205, 20, 2135, 20C, 30B, 40B, 20D, 30E, 40E

735057M1

Valve Cover Gasket



Fits 135, 150, 230, 235, 245, 231, 240, 250, 253, 360, 362, 202, 203, 204, 205, 20, 2135, 20C, 30B, 40B, 20D, 30E, 40E

737055M1

Distributor Drive Shaft
AG3.152 Perkins Gas



Fits 135, 20, 2135



Massey Ferguson

ENGINE, MANIFOLDS

735016M1

Exhaust Manifold Gasket

Fits 20, 2135, 230, 235, 245, 231, 240, 250, 253, 360, 362, 20, 2135, 20C, 30B, 40B, 20D, 30E, 40E



507629M1

Exhaust Elbow

Fits 65, 165, 3165, 30



732814M1

Exhaust Manifold Gasket

Fits 65, 165, 302, 304



736218M1

Exhaust Manifold

Fits 165, 30, 3165



736754M1

Exhaust Manifold Gasket

Fits 175, 180, 255, 265, 275, 270, 282, 283, 375, 383, 390, 390T, 398, 399



734700M1

Replaces 37781321
Exhaust Manifold

Fits 175, 180, 255, 265, 275, 50C



180104M1

Exhaust Gasket

Fits 35, 50, 65, 135, 150, 230, 235, 245, 20, 202, 203, 204, 205, 20C, 2135, 30B, 30D



533446M2

Exhaust Elbow
AD4.236 & AD4.248
Engines

Fits 255, 265, 275, 50C, 50D



731267M91

Exhaust Manifold
For A3.152 Engines

Fits 35, 202, 203, 204, 205



741764M1

Replaces 37781051
Exhaust Manifold
AD4.236 & AD4.248
Engines

Fits 255 265, 275, 50C, 50D



734921M1

Exhaust Manifold

Fits 135, 150 Prior to S/N 9A15748, 230, 235, 245, 20, 30, 20C, 30B, 30D, 2135



741771M1

Exhaust Manifold

Fits 285, 298



744232M1

Exhaust Manifold

Fits 230, 245, 20C, 30B, 30D



738663M1

Replaces 737147M1
Exhaust Manifold

Fits 1080, 1085
(Will Work On 698 With Some Modification)



MUFFLERS & FUEL

Massey Ferguson

1693855M1

Exhaust Elbow
8 Inches Long



Fits 135UK, 231, 231S, 240, 250, 20E

1865534M1

Exhaust Elbow
6 Inches Long



Fits 135UK, 240, 250, 20E

1694961M5

Muffler



Fits 365, 375, 383, 390

1694965M1

Muffler
For 6-354.4 and
1006.6 Engines



Fits 399

1694963M5

Muffler



Fits 390, 390T, 393, 398

189209M93

Fuel Tank
For Tractors With 4 Cylinder
Continental Gasoline Engines



Fits 35, 135, 20, 2135, 202, 203, 204, 205

897401M1

Fuel Tank, Diesel
For 3 Cylinder Perkins Diesel
and 3 Cylinder Perkins Gas
Tractors



Fits 35, 135, 20, 2135, 202, 203, 204, 205

1672762M91

Fuel Tank, Diesel

Fits 20D, 20F, 30E, 30H, 240,
250, 231



1698042M91

Fuel Cap

Fits 231, 240, 250, 253, 360, 362, 270, 282,
283, 290, 298



897403M91

Fuel Sending Unit

Fits 135UK



1661794M92

Fuel Sending Unit

Fits 20D, 20E, 20F, 250, 30E, 30H, 40E, 240



898540M91

Fuel Shut Off Valve

Fits 135, 148, 20D, 20E, 20F, 230, 231,
240P, 240S, 250, 261, 30E, 40E



1851653M91

Fuel Shut Off Valve

Fits TE20, TEA20, TO20, TO30, 165, 20D,
20E, 231, 240P, 255, 261, 2640, 30E, 35,
3505, 3525, 3545, 50, 65



Massey Ferguson

FUEL

3637288M91

Fuel Lift Pump with Bowl
A3.152 & AD3.152
2 Hole



Fits 35, 50, 135, 150, 202, 203, 204, 205, 20, 2135

3637309M91

Fuel Lift Pump
AD6.354
2 Hole



Fits 1105, 1135

3637307M91

Fuel Lift Pump
AD3.152
2 Hole



Fits 20, 2135, 230, 235, 245, 20, 2135, 20C, 30B, 40B

1446951M91

Fuel Lift Pump
4 Hole



Fits 3090, 3095, 3120, 3125, 3140, 3630, 3645, 3650, 3655, 3660, 6150, 6170, 6180, 8120, 2640, 2675, 2705, 3505, 3545, 3525, 396, 399, 699

3637292M91

Replaces 2641808, 4222090M91

Fuel Lift Pump
AD3.152
4 Hole



Fits 230, 235, 245, 231, 240, 250, 253, 360, 362, 20C, 30B, 40B, 20D, 30E, 40E

3637287M91

Fuel Lift Pump
AD4.236
2 Hole



Fits 165, 175, 180, 255, 265, 275, 253, 360, 362

3637338M91

Fuel Lift Pump with Bowl
A4.203
2 Hole



Fits 65, 165, 302, 304, 30, 31, 40, 3165

1447688M91

Replaces 3637290M91

Fuel Lift Pump
AD4.236 & AD4.248 Late
4 Hole



Fits 175, 180, 1080, 1085, 255, 265, 275, 285, 270, 282, 283, 290, 298, 375, 383, 390, 390T, 398, 399

3637286M91

Replaces 886100M91

Fuel Lift Pump
AD4.203
2 Hole



Fits 165, 255, 302, 304, 30, 31, 40, 3165, 285, 1085

4224451M91

Fuel Lift Pump



Fits 271, 281, 281X, 281XE, 283UK, 4225, 4233, 4235, 4240, 4243, 4245, 4253, 4255, 4265, 4325, 4335, 4345, 4355, 6140, 6150, 6235, 6245, 6255, 6265; Landini, McCormick, CASE CX70, CX90, CX90, CX100, MC100, MX80C, MX90X, MX100C, MX80, MX90 and More



FUEL

Massey Ferguson

INJPUMP04

Replaces 3230030,
3241F030, 3830F030,
881306M91

Injection Pump A3.152
3 Cylinder, Regular Injection

Fits 35, 50, 202, 203, 204, 205



INJPUMP06

Replaces 1446012M91, 1447205M91,
3230F350, 3230240, 3230F180, 3230F450

Injection Pump AD3.152
3 Cylinder, Direct Injection

Fits 135, 150, 230, 235, 245, 231, 240, 250, 20, 2135

INJPUMP05

Replaces 3240F938, 3240938, 3240768,
1447156M91, 883517M91, 899071M91

Injection Pump AD4.203
4 Cylinder, Direct Injection
3 Bolt Drive

Fits 65, 165, 30, 3165, 255

INJPUMP08

Replaces 1446876M91, 3240758, 3240848,
3240F758, 3240F848, 3241350, 3241360,
3841F360, 883545M91, 899070M91

Injection Pump AD4.236, AD4.248
4 Cylinder

Fits 175, 180, 255, 265, 275, 270, 282, 283, 375, 383, 390,
390T, 398

1447605M1

Replaces 144182M1, 1446202M1,
1447178M1

Injection Pump AD4.318
4 Cylinder

Fits 285, 298, 698, 1080, 1085

3637314M1

Injection Pump AT4.236

Fits 390T, 393, 398, 3065, 3070

7123-515A

Replaces 1851859M1
Inj Pump Side Cover Gasket



7123-287

Replaces 1851882M1
Inj Pump Top Cover Gasket



731176M1

Triangle Gasket For
Injection Pump Mounting



380426S

Sealing Washer
For Top Cover



568-010

O-Ring
For Top Cover Lever Shafts



5393-252U

Seal
For CAV Injection Pump
Drive Hub



Fits Most LUCAS/CAV Injection Pumps

7123-764S

Head and Rotor
AD3.152, 3 Cylinder

Fits 20, 2135, 230, 235, 245, 231,
240, 250, 20D, 30E, 40E



7123-340S

Head and Rotor
For 4.236 and 4.248 Perkins
Engines



Fits 175, 180, 255, 265, 275, 270,
282, 283, 375, 383, 390, 390T, 398

Massey Ferguson

FUEL

7135-110

Injection Pump Repair Kit
For CAV DPA Style Pumps

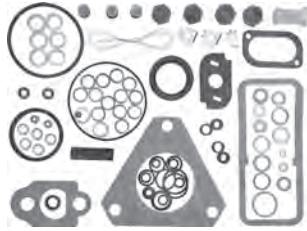

7123-388

Transfer Pump Blade Kit
For CAV DPA Style Pumps



1851890M1

Replaces **7111/296**
Fuel Filter (Short Type)

Fits 135, 150, 165, 175,
180, 230, 235, 245, 1080,
302, 304, 20, 2135, 20C,
30B, 40B, 30, 31, 40, 3165



7111-796

Replaces **1896287M1**
Fuel Filter (Long Type)

Fits 230, 235, 245, 1085, 255, 265, 275, 285, 231, 240,
250, 253, 360, 362, 270, 282, 283, 290, 298, 375, 383,
390, 390T, 398, 399, 670, 690, 698, 699

1446788M91

Replaces **5281613, 6554**
Injector



Fits 135, 230, 235, 245, 255, 150, 20,
2135, 30, 40, 40B, 50, 50A, 65, 165,
3165, 2500 and 4500 Forklift

1446761M91

Replaces **1447288M91**
Injector
For 4.236 Engines



Fits 175, 180, 255, 265, 270, 274-4, 294-4, 362, 365, 374S,
374V, 375, 384S, 670, 3050, 31, 50C, 50D, 50E, 50F, 50H,
6500, 6500H, 6800H

1447401M91

Injector
For AD3.152 and AD4.203 Engines



Fits 230, 231, 240, 250, 255, 275, 20D, 20F, 30E, 30H, 40B

1447218M91

Injector
For AD4.236 Engines



Fits 275, 283, 383, 390, 394S, 690, 3060, 50H, 60H, 60

1447136M91

Fuel Filter Base



Fits 35, 50, 65, 135, 150, 165, 175, 180,
202, 203, 204, 205, 20, 2135, 30, 40,
3165, 25, 130, Super 90

1044869M1

Replaces **1891262M1**
Fuel Filter Base



1692890M91

Replaces **1447072M91,**
1876507M91, 3597838M91
Fuel Filter Assy



Fits 230, 235, 245, 1085, 255, 265, 275, 285,
231, 240, 250, 253, 360, 362, 270, 282, 283,
290, 298, 375, 383, 390, 390T, 398, 399, 670,
690, 698, 699

1024386M1

Fuel Bowl, Glass
Flat Bottom



Fits 35, 50, 65, 135, 150, 165, 175, 180,
230, 235, 245, 1080, 302, 304, 20, 2135,
20C, 30B, 40B, 30, 31, 40, 3165

1039071M1

Fuel Bowl, Glass
Round Bottom



Fits 230, 235, 245, 1085, 255, 265, 275,
285, 231, 240, 250, 253, 360, 362, 270, 282, 283, 290,
298, 375, 383, 390, 390T, 398, 399, 670, 690, 698, 699



FUEL

Massey Ferguson

Flexible Fuel Lines
Replace Steel Fuel Lines Easily



2500

Fuel Line, 14" Long

2501

Fuel Line, 16" Long

2502

Fuel Line, 26" Long

2503

Fuel Line, 22.5" Long

2504

Fuel Line, 32.5" Long

2505

Fuel Line, 38" Long

2506

Fuel Line, 41.5" Long

12566

Replaces TSX28, TSX34,
TSX85, TSX88, TSX155,
TSX186, TSX248, TSX272,
TSX306, TSX309, TSX312,
TSX361, TSX361A, TSX447,
TSX458, TSX541, TSX605,
TSX606, TSX683, TSX882

Carburetor for Continental Engines
Z120, Z129, Z134, Z145

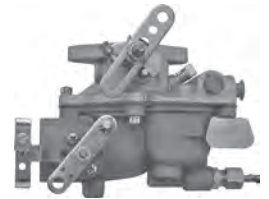

Fits TO20, TO30, TO35, F40, 35, 50, 135, 150, 202, 203,
204, 205, 2135, 20 IND

533969M91

Carburetor For 4 Cylinder
Continental Engines



Fits TO20, TO30, TO35, F40, 35, 50, 135, 150, 202, 203,
204, 205, 2135, 20 IND

1037757M1

Fuel Bowl Drain Washer

1039073M1

Fuel Bowl Washer

376524X1

Fuel Line Seal
3/16" x 5/16" x 3/16"

376525X1

Return Fuel Line Seal
1/4" x 1 27/64" x 15/64"

376526X1

Fuel Line Compression Sleeve

732824M1

Injector Dust Shield

376091X1

Injector Copper Washer

Fits Most MF Tractors

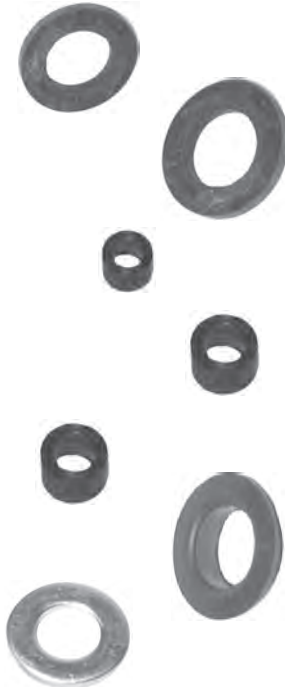

14996

Replaces TSX695, TSX772,
TSX856, TSX884, TSX947SL
Carburetor For Continental
Engines G176



Fits 65, 302, 304, 356, 1001

13338

Replaces 517099M93
Carburetor For
Perkins AG3.152



Fits 135, 2200, 20, 40

Massey Ferguson

FUEL

BK48V

Carburetor Kit
For TSX361A and TSX458
Carburetors



Fits TO20, TO30

BK49V

Carburetor Kit
For Continental Z Series
Engines



Fits 35, 50, F40, 65, 135, 150, 202, 203, 204, 205, 20, 2135

15480A

Float
For Small Marvel
Schebler Carburetors



Fits TO20, TO30, 35, 50, F40, 65, 135, 150, 202, 203, 204,
205, 20, 2135

PC7-2.25

Pre-Cleaner Assembly
7" Bowl, 2.25" Mount



PC7-2.50

Pre-Cleaner Assembly
7" Bowl, 2.50" Mount



PC10-3

Pre-Cleaner Assembly
10" Bowl, 3" Mount

PC10-3.5

Pre-Cleaner Assembly
10" Bowl, 3.5" Mount

PC10-4

Pre-Cleaner Assembly
10" Bowl, 4" Mount

PC10-4.5

Pre-Cleaner Assembly
10" Bowl, 4.5" Mount



ELECTRICAL

Massey Ferguson

181541M91

Starter, MF
For Gas Engines
Z120, Z129, Z134



Fits TO20, TO30, TO35, 35

579541M91

Alternator



Fits 230, 245, 255, 265, 275, 285, 1085, 1105, 1135, 20C, 30B, 40B, 4500, 6500

3763363M94

Starter, MF
3.152, 4.203 Engines



Fits 135, 150, 165, 230, 235, 245, 255, 231, 240, 250, 253, 360, 362, 202, 203, 204, 205, 20, 2135, 20C, 30B, 40B, 20D, 30E, 40E, 3165

0011899U91

Alternator



Fits 231S, 241, 240S, 265S, 285S, 271, 281

3763362M91

Replaces 1868285M3, 1691806M1, 579488M91,
517533M92, 534191M91, 1860093M1, 186285M3
Starter, MF
4.236, 4.248 Engines

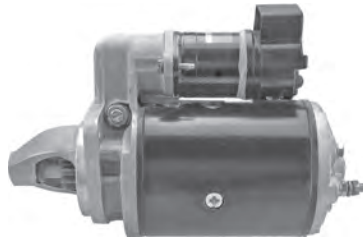

Fits 175, 180, 255, 265, 275, 270, 282, 283, 290, 375, 383, 390, 390T, 398, 399, 6150, 6170, 6180, 30, 31

7003559M1

Replaces 1075447M91
Alternator



Fits 231, 240P, 261

504809M1

Starter Switch
For Diesel Tractors
2 Prong



Fits 50, 135, 150, 165, 175, 180, 230, 235, 245, 255, 265, 275, 285, 1085, 1080, 1100, 1105, 1130, 1135, 1150, 1155, 20, 2135, 30, 3165, 30B, 40C, 50, 50A, 50C

3435016M91

Starter, MF

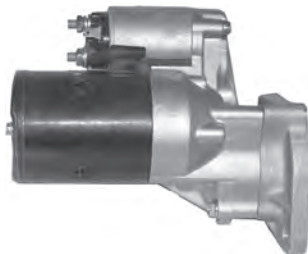

Fits 1010, 1020, 1030, 1035

Massey Ferguson

ELECTRICAL

TUKMF01

Tune Up Kit
For Tractors With
Continental Z Series Engines
and Clip On Cap

Contains Ignition Kit, Spark Plugs,
Plug Wires, and Distributor Cap
For Individual Parts Order Below



ATK1DCR

Ignition Kit With Rotor



AL386

Spark Plug



SWS259

Spark Plug Wire Set



1750411M91

Distributor Cap
Clip On Type



Fits TO20, TO30, TO35, F40, 35, 50, 65, 135, 150, 230,
235, 245, 202, 203, 204, 205, 2135, 20 IND

TUKMF03

Tune Up Kit
For Tractors With 4 Cylinder
Continental Z Series Engines,
with Screw On Cap



Contains Ignition Kit, Spark Plugs,
Plug Wires, and Distributor Cap
For Individual Parts Order Below



ATK10DSR

Ignition Kit With Rotor



AL386

Spark Plug



SWS259

Spark Plug Wire Set



1024914M91

Distributor Cap
Screw On Type



Fits 25, 50, 65, 135, 150, 165, 175, 180, 203, 235, 245, 20,
2135, 202, 203, 204, 2200, 2500, 3165, 356

TUKMF02

Tune Up Kit
For Tractors With Perkins Engines

Contains Ignition Kit, Spark Plugs,
Plug Wires, and Distributor Cap
For Individual Parts Order Below



ATK10DSR

Ignition Kit With Rotor



AL295

Spark Plug



SWS259

Spark Plug Wire Set



1035263M1

Distributor Cap
Screw On Type



Fits 135, 150, 20, 2135



ELECTRICAL

Massey Ferguson

16-RU12

Resistor

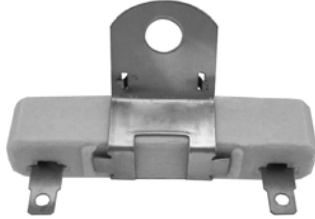

Fits Universal

1750491M91

Dust Cover
For Clip On Type Cap



Fits TO20, TO30, TO35, F40, 35, 50, 65, 135, 150, 230, 235, 245, 202, 203, 204, 205, 2135, 20 IND

1024481M91

Ignition Coil



Fits TO20, TO30, TO35, F40, 35, 50, 65, 135, 150, 230, 235, 245, 202, 203, 204, 205, 2135, 20 IND

SWS259

Spark Plug Wire Set



Fits Most 3 & 4 Cylinder Applications

182852M91

Replaces 1111722,
1111740, 1112570,
1112586, 181686M91

Distributor
For 4 Cylinder Gas Z120, Z129, and Z134
Engines



Fits TO20, TO30, T035, 35, F40, 50, 202, 203, 204, 205

Massey Ferguson

ELECTRICAL

A0NN10670A
Replaces FAD10850A,
360053R91, 378424R91,
393334R91, 208302
 Amp Gauge, Chrome



Fits all Ford models prior to 1958, Massey Ferguson TO35, 35, 50, 65, 85, 165, Super 90, Case/IH Cub (to S/N 248125), Cub 184, 140 (to S/N 57724), 454, 464, 574, 674, 2400A, 2500A, Allis Chalmers B, C, D10, D12, D14, D15, D17, D19, D21, WC, WD45, WD45 Diesel, WF, 170, 190

9N9273A
Replaces 506902M1, 9A550,
FAD9273A
 Oil Pressure Gauge, Chrome



Fits Most Massey Ferguson Tractors

UTG25
 Temperature Gauge
 Adapter is 1/2" - 14 NPT
 Probe is 5/8" - 18 thread
 6' Cable



Fits Universal

194428M91
Replaces 836975M91
 Temperature Gauge



504677M91
Replaces 528418M91
 Amp Gauge



504687M91
Replaces 504687M93,
528415M91
 Oil Pressure Gauge



504695M92
Replaces 836975M91
 Fuel Gauge



528403M91
Replaces 1078005M91,
194615M1
 Tachometer



Looks Different, But Works Well

Fits 135, 150, 165, 20, 2135, 3165

COOLING

Massey Ferguson

885344M1
Replaces 885341M1,
3637301M1, 826772M1
 Radiator Cap



Fits All Small MF

1446222M91
 Thermostat



Fits 65, 165, Super 90, 1100, 1130, 255, 30, 300, 302, 304, 3165, 40B, 410, 50, 50A

186819M91
 Fan Blade
 With Trapezoidal Bolt Pattern
 For Perkins A3.152



Fits 35, 50, 202, 203, 204, 205

830862M91
 Water Pump
 For Z120, Z129 Gas Engine



Fits TO20, TO30

830691M91
 Water Pump
 For Z134, Z145 Gas Engine



Fits 35, 135, 230, 245, 202, 203, 204, 205, 20, 2135, 20C

1750081M1
 Water Pump Pulley



Fits 35, 202, 203, 204, 205, 135, 235, 20, 2135, 2200, 4500

1885489M92
 Water Pump without Pulley
 Standard Engine
 Gas & Diesel



Fits TE20, 35

742558M91
 Water Pump with Pulley
 A3.152 with Trapezoidal
 Fan Bolt Pattern



Fits 35, 50, 202, 203, 204, 205

Massey Ferguson

COOLING

739527M91
Replaces U5MW0023,
747542M91, 735034M1
 Water Pump with Pulley
 AD3.152
 Diesel & Gas



Fits 20, 135, 2135, 230, 235, 245, 231, 240, 250, 253,
 360, 362, 202, 203, 204, 205, 20, 2135, 20C, 30B, 40B,
 20D, 30E, 40E

3637468M91
Replaces 3638998M91
 Water Pump without Pulley



Fits 375, 383, 390, 390T, 398, 399

3641250M91
Replaces U5MW0061,
3637372M91, 731807M91
731638M91, 739692M91,
740611M91
 Water Pump with Pulley
 AD4.203



Fits 65, 165, 255, 302, 304

3637468WP
Replaces 3638998M91
 Water Pump



Same as
 3637468M91
 But With Pulley

Fits 375, 383, 390, 390T, 398, 399

743064M91
Replaces 41312551,
3637411M91
 Water Pump
 5" Pulley
 AD4.236, AD4.248



Fits 165, 175, 180, 255, 265, 275

3757045M91
Replaces 3757045M92,
3757045M93, CSU80-0019
 Water Pump



Fits 1240, 1250, 1260, 1429, 1433V, 1433, 1440V, 1440,
 1520, 1529, 1532, 1533, 1540 AGCO: ST30, ST34A, ST35,
 ST35H, ST35X, ST40, ST40H, ST40X, ST41A Challenger:
 MT265, MT265B, MT265H, MT275, MT275B, MT285,
 MT285

3641219M91
Replaces 4131A013
 Water Pump
 6" Pulley
 AD4.236, AD4.248



Fits 261, 270, 282, 283, 290, 298, 670, 690

COOLING

Massey Ferguson

181623M1

Radiator
Core Dimensions:
17 1/4" x 15 3/8"



Fits TO20, TO30, TO35, 35, 202,
203, 204, 205 All with
Continental Gas Engines

579004M91

Radiator
Core Dimensions:
18.5" x 15.5"
Filler Neck Height 3.25"



Fits 230, 245, 20C

894319M92

Radiator
Core Dimensions:
17 1/2" x 15 1/2"



Fits 35 With A3.152
Perkins Engines
and 87mm Standard
Diesel Engines

1680547M91

Radiator
Core Dimensions:
18.5" x 15.375"



Fits 231, 240, 250, 20D, 20F, 30E,
30H, 40E

1660499M92

Radiator
Diesel & Perkins Gas
Core Dimensions:
18.5" x 15.5"



Fits 135, 2135, 20

3599709M92

Radiator
Core Dimensions:
18 3/8" x 15 1/4"



Fits 240 Late, 253

539919M91

Radiator
Core Dimensions:
18.5" x 15"
Filler Neck Height 4.25"



Fits 230, 245, 20C

1660655M92

Radiator
Core Dimensions:
18.5" x 15.375"



Fits 231, 240P

Massey Ferguson

COOLING

1669650M94

Radiator



Fits 260, 270, 283, 290

1695721M2

Radiator

Core Dimensions:
20 1/16" x 19 1/2"



Fits 375, 383, 390, 390T, 393, 398, 399
(With A6.354 Engine)

506244M91

Radiator

Core Dimensions:
19" x 15"



Fits 165, 175, 180, 30, 31, 3165

CLUTCH

Massey Ferguson

CKMF01

Clutch Kit

Contains Clutch, Pressure Plate, Release Bearing, Pilot Bearing, and Alignment Tool

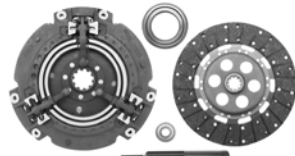

For Tractors with Dual Pressure Plate 9", 10 Spline PTO Disc and 11", 10 Splines Main Clutch Disc

Individual Parts Sold Below

516068M91

Clutch Disc
11", 10 Splines



526665M91

Replaces 3620402M91
Dual Pressure Plate
9-11", Regular Duty, 10 Spline

832960M1

Pilot Bearing



833084M1

Release Bearing

Fits 135, 150, 165, 175, 180, 202, 203, 204, 205, 302, 304, 20, 2135, 30, 31, 40, 3165

CKMF02

Clutch Kit

Contains Clutch, Pressure Plate, Release Bearing, Pilot Bearing, and Alignment Tool

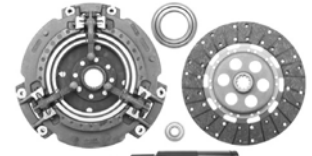

For Tractors with Dual Pressure Plate 9", 25 Spline PTO Disc and 11", 10 Splines Main Clutch Disc

Individual Parts Sold Below

516068M91

Clutch Disc
11", 10 Splines



532320M91

Dual Pressure Plate
9-11", Regular Duty, 25 Spline

832960M1

Pilot Bearing

833084M1

Release Bearing

Fits 230, 235, 245, 255, 265, 275, 231, 240, 250, 253, 360, 362, 202, 203, 204, 205, 20C, 30B, 40B, 20D, 30E, 40E

CKMF03

Clutch Kit

Contains Clutch, Pressure Plate, Release Bearing, Pilot Bearing, and Alignment Tool



For Tractors with Dual Pressure Plate 10", 25 Spline PTO Disc and 12", 10 Splines Main Clutch Disc

Individual Parts Sold Below

3599462M92

Clutch Disc
12", 10 Splines



3599463M91

Dual Pressure Plate
12"

832960M1

Pilot Bearing

833084M1

Release Bearing

Fits 231, 240, 250, 253, 360, 362, 270, 282, 283, 290, 298, 375, 383, 390, 390T, 398, 399, 20D, 30E, 40E

CKMF04

Clutch Kit

Contains Clutch, Pressure Plate, Release Bearing, Pilot Bearing, and Alignment Tool

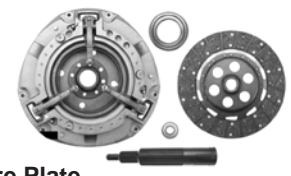

For Tractors with Dual Pressure Plate 10", 25 Spline PTO Disc and 12", 21 Splines Main Clutch Disc

Individual Parts Sold Below

3610274M92

Clutch Disc
12", 21 Splines,
1 1/8" Center



3599463M91

Dual Pressure Plate
12"

832960M1

Pilot Bearing

833084M1

Release Bearing

Fits 231, 240, 253, 261, 263, 271, 271X, 271XE, 281, 281X, 281XE, 283, 285S, 360, 362, 365, 375, 383, 390, 431, 451, 471, 481, 533, 573, 583

Massey Ferguson

CLUTCH

CKMF05

Clutch Kit

Contains Clutch, Pressure Plate, Release Bearing, Pilot Bearing. Without Alignment Tool

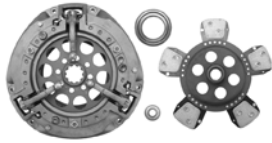

For Tractors with Split Torque Pressure Plate 10 Spline Fixed PTO Hub and 12", 21 Spline Rigid Main Clutch Disc

Individual Parts Sold Below

3701008M91

Clutch Disc
21 Splines, Rigid Center



3701004M91

Pressure Plate
12", 10 Spline
Fixed PTO Hub

832960M1

Pilot Bearing



833084M1

Release Bearing

Fits 275 UK, 290, 362, 365, 375, 383, 390

CKMF06

Clutch Kit

Contains Clutch, Pressure Plate, Release Bearing, Pilot Bearing. Without Alignment Tool

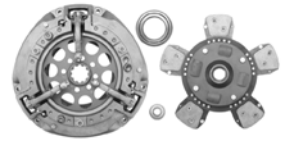

For Tractors with Split Torque Pressure Plate 10 Spline Fixed PTO Hub and 12", 21 Spline Spring Type Main Clutch Disc

Individual Parts Sold Below

3701009M91

Clutch Disc
21 Splines, Spring Center



3701004M91

Pressure Plate
12", 10 Spline
Fixed PTO Hub

832960M1

Pilot Bearing



833084M1

Release Bearing

Fits 362, 365, 375, 383, 390, 4225, 4235, 4240

CKMF07

Clutch Kit

Contains Clutch, Pressure Plate, Release Bearing, Pilot Bearing, and Alignment Tool



For Tractors with Split Torque Pressure Plate 25 Spline Fixed PTO Hub and 12", 10 Spline Rigid Main Clutch Disc

Individual Parts Sold Below

3701010M91

Clutch Disc
10 Splines, Rigid Center



3700166M91

Pressure Plate
12", 25 Spline
Fixed PTO Hub

832960M1

Pilot Bearing



833084M1

Release Bearing

Fits 275 UK, 290

CKMF08

Clutch Kit

Contains Clutch, Pressure Plate, Release Bearing, Pilot Bearing, and Alignment Tool



For Tractors with Split Torque Pressure Plate 25 Spline Fixed PTO Hub and 12", 10 Spline Spring Type Main Clutch Disc

Individual Parts Sold Below

3697163M91

Clutch Disc
10 Splines, Spring Center



3700166M91

Pressure Plate
12", 25 Spline
Fixed PTO Hub

832960M1

Pilot Bearing



833084M1

Release Bearing

Fits 362, 365, 375, 383, 390



CLUTCH

Massey Ferguson

CKMF09

Clutch Kit



Contains Clutch, Pressure Plate, Release Bearing, Pilot Bearing, and Alignment Tool



**For Tractors with Split Torque Pressure Plate
25 Spline Fixed PTO Hub and 12", 21 Spline Rigid
Main Clutch Disc**

Individual Parts Sold Below

3610274M92

Clutch Disc

12", 21 Splines,
1 1/8" Center



3700166M91

Pressure Plate

12", 25 Spline
Fixed PTO Hub



832960M1

Pilot Bearing



833084M1

Release Bearing



Fits 240, 253, 261, 263, 285S, 360, 362, 365, 375, 383,
390, 471, 481, 573, 583

1753747M2

Replaces 886399M1

Pressure Plate Cover
For 11" Pressure Plate



Fits 35, 50, 65, 135, 150, 165, 175, 180, 230, 235, 245,
255, 265, 275, 20, 2135, 30, 40

533601M94

Clutch Pedal Bracket



Fits 230, 235, 245, 255, 265, 275, 285, 20C, 30B, 30D, 40,
40B, 50C, 50D



Massey Ferguson

TRANSMISSION

195523M1

Input Shaft Seal
6 Speed, 1.25" x 2.25" x .25"

Fits 35, 50, 65, 135, 150,
165, 175, 180, 1080



195501M1

Input Shaft Seal
6 Speed 1 1/8" x 1 9/16" x 3/8"

Fits 35, 50, 65, 135, 150, 165, 175, 180, 1080

195503M1

Input Shaft Seal
6 Speed, 1.75" x 2.25" x .25"

Fits 35, 50, 65, 135, 150, 165, 175, 180, 1080, 230, 235,
245

192329M1

Input Shaft Seal
For Multipower, 1 5/8" x 2.00" x 19/32"
Fits Over Outside of Input Housing

Fits 35, 50, 65, 135, 150, 165, 175, 180, 1080

883935M1

Input Shaft Seal
Multipower 1 5/8" x 2.00" x 19/32"

Fits 35, 50, 65, 135, 150, 165, 175, 180, 1080

886673M1

Input Shaft Seal
For Multipower 1 19/32" x 2.00" x 9/32"

Fits 35, 50, 65, 135, 150, 165, 175, 180, 1080

1860867M1

Input Shaft Seal
Multipower, 8 Speed, Manual Shuttle
1 5/8" x 1 15/16" x 15/64"

Fits 100, 200, 300 Series Tractors

886668M1

Retainer Bearing
Used on 1860889M1 Retainer



Fits 35, 50, 65, 135, 150, 165, 175, 180, 235, 245, 255,
265, 270, 275, 285, 290

1663178M1

Shift Lever Pin
1/4" x 2 1/16"



180581M1

Shift Lever Pin
1/4" x 1 3/4"



Fits F40, MH50, TO35, 135, 150, 165, 175, 20, 20C, 20D,
20F, 202, 203, 204, 205, 2135, 220, 2200, 230, 235, 240,
245, 250, 2500, 255, 265, 275, 283, 285, 30, 30B, 30D,
30E, 30H, 302, 304, 31, 3165, 320, 35, 356, 40, 40B, 40E,
4500, 4800, 4840, 50, 50A, 50C, 50D, 60, 65, 6500, 85, 88,
Super 90

827690M1

Replaces 827211M1
Gear Shift Cup and Nut



Fits 231, 240, 250, 20D, 20E, 30D, and Aftermarket
Steering Sectors

1673814M2

Replaces 891405M1, 194550M3
Transmission Shift Lever

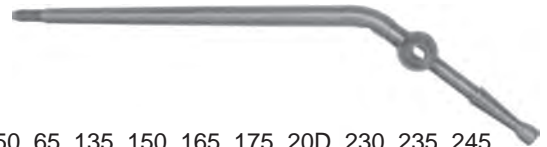

Fits 35, 50, 65, 135, 150, 165, 175, 20D, 230, 235, 245,
255, 265, 275, 285, 30, 30E, 40, 40E, 20F

520858M1

Replaces 180579M1
Gear Shift Boot



192007M1

Shifter Spring
Fits all TE, TO, & MF Models



1679223M2

Neutral Safety Switch



Fits 240, 250, 253, 265, 298, 30E, 30H, 383,
393, 40E, 50E, 50EX, 50H, 50HX, 550, 565, 575, 590, 60H,
360, 365, 399, 375, 390, 390T, 398

TRANSMISSION

Massey Ferguson

1693833M92

Replaces 1860890M91

Input Shaft Retainer Assy
For 8 & 12 Speed Transmission



Fits 135, 150, 165, 175, 235, 240, 245, 250, 255, 265, 360,
362, 375, 383, 390, 390T, 398, 399

1860889M1

Multi Power Input Housing



Fits 35, 50, 65, 135, 150, 165, 175, 180, 230, 235, 245,
255, 265, 275

180437M1

Shift Fork



Fits 35, 40, 50, 65, 135, 150, 165,
175, 180, 230, 235, 245, 255, 265,
270, 275, 285, 1080, 1085, 290, 298, 202, 203, 204, 205,
20, 20C, 20D, 2135, 2200, 30, 31, 3165

1860773M1

Shift Fork, 8 Speed



Fits 135, 150, 165, 175, 180, 230,
235, 245, 255, 265, 275, 231, 240,
250, 253, 360, 362, 20, 2135, 20C,
30B, 40B, 20D, 30E, 40E, 30, 31, 40, 3165

906919M91

Replaces 1860009M91

PTO Shaft Input, 8 Speed
17 Teeth, 10 Spline



Fits 135, 150, 165, 175, 180, 20, 2135, 30, 31, 40, 3165

1868531M1

PTO Shaft Input, 8 Speed
17 Teeth, 25 Spline



Fits 135, 150, 165, 175, 180, 230, 235, 245, 255, 265, 275,
253, 360, 362, 270, 282, 283, 20, 2135, 20C, 30B, 40B, 30,
31, 40, 3165

899332M92

PTO Shaft Input, Multipower
17 Teeth, 10 Spline



Fits 135, 150, 165, 175, 180, 20, 2135, 30, 31, 40, 3165

1868528M92

Replaces 1868528M91

PTO Shaft Input, Multipower
17 Teeth, 25 Spline



Fits 135, 150, 165, 175, 180, 230, 235, 245, 255, 265, 275

Massey Ferguson

TRANSMISSION

1808811M92

Replaces 1808810M2
PTO Shaft Input, Multipower
23 Teeth, 25 Spline



Fits 1080, 1085, 285

908490M91

PTO Shaft Input, 8 Speed
23 Teeth, 10 Splines



Fits 285, 1080, 1085

180420M1

Shaft Input, 6 Speed
18 Teeth, 10 Spline



Fits 35, 50, 65, 135, 150, 165, 175, 180, 230, 235, 245, 255, 265, 275, 202, 203, 204, 205, 302, 304, 20, 2135, 20C, 30B, 40B, 30, 31, 40, 3165

1862423M3

Input Shaft, 8 Speed
26 Teeth, 10 Spline, 13.730" Long



Fits 135, 150, 165, 175, 180, 230, 235, 245, 240, 250, 255, 265, 275, 253, 261, 270, 282, 283, 290

964926M3

Input Shaft, 8 Speed
18 Teeth, 10 Splines



Fits 135, 150, 165, 175, 180, 230, 235, 245, 231, 240, 250, 20C, 30B, 40B

964925M3

Input Shaft, 8 Speed
24 Teeth, 10 Spline

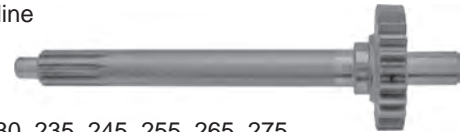

Fits 20, 2135, 230, 235, 245, 255, 265, 275, 231, 240, 250, 270, 282, 283, 20D, 30E, 40E

516523M92

Replaces 516523M91
Input Shaft, Multipower
10 Spline



Fits 35, 50, 65, 135, 150, 165, 175, 180, 230, 235, 245, 1080, 1085, 255, 265, 275, 285, 202, 203, 204, 205, 20, 2135, 20C, 30B, 40B, 20D, 30E, 40E, 30, 31, 40, 3165



TRANSMISSION

Massey Ferguson

183054M92

Countershaft
6 Speed & Manual Shuttle
15 Teeth, 17 and 20 Splines



Fits FE35, TO35, 35, 50, 65, 135, 150, 165, 175, 180, 1080, 230, 235, 245, 20, 20C, 20D, 202, 203, 204, 205, 2135, 2200, 30, 31

1687642M1

Replaces 1870151M1, 1682448M1

Mainshaft
8 Speed Transmission
22 Teeth, 18 Splines
13.375" Long



Fits 135, 150, 165, 175, 180, 1080, 1085, 240, 250, 255, 265, 270, 275, 282, 283, 285, 290, 298, 360, 375, 383, 390, 390T, 50E, 50H, 550, 565, 575, 590

189391M92

Countershaft
Multipower Transmission
15 Teeth
32, 30, and 17 Splines
12.250" Long



Fits 35, 50, 65, 135, 150, 158, 165, 175, 180, 235, 240, 245, 250, 255, 265, 270, 275, 285, 1080, 1085, 290, 298, 30, 550, 565, 575, 590

1687643M1

Replaces 1870149M1

Mainshaft
8 Speed Transmission
18 Spline
13.500" Long



Fits 135, 150, 165, 175, 180, 1080, 1085, 20, 20C, 20F, 231, 235, 240, 245, 250, 253, 255, 265, 275, 285, 290, 30, 30B, 30D, 31, 360, 362, 40, 40B, 40E, 50C, 50D, 550, 565, 575, 590

906472M2

Replaces 906473M92

Countershaft
8 Speed Transmission
15 Teeth, 17 and 20 Splines
12.250" Long



Fits 135, 150, 165, 175, 180, 1085, 231, 235, 240, 245, 250, 253, 255, 265, 270, 275, 282, 283, 285, 290, 298, 30, 31, 360, 362, 375, 383, 390, 390T, 20, 20C, 20D, 20F, 40, 40B, 40E, 50C, 50D, 50E

880955M1

Replaces 894702M1

Mainshaft
6 Speed Transmission
18 Spline
11.843" Long



Fits 135, 150, 165, 175, 180, 230, 235, 245

1682542M1

Replaces 520701M3

Mainshaft
Multipower and 6 Speed
Transmission
18 Splines
12.250" Long



Fits 135, 150, 165, 175, 180, 230, 235, 245, 255, 265, 275, 285, 1080, 1085, 240, 250, 290, 30



Massey Ferguson

INSTANT REVERSE TRANSMISSION

1754395M1

Ring, Input Shaft Oil Tube Seal
5/8" O.D. (2 Required)



Fits 204, 205, 302, 304, 30, 30B, 30D, 30E, 40, 40B, 50, 50A, 50B, 50C, 50D, 50E, 50F, 60, 2200, 2500, 4500, 6500

1754344M1

Clutch Plate
External Spline



1754402M1

Metal Seal Ring, Medium
(3 Required)



Fits 204, 205, 302, 304, 30, 30B, 30D, 30E, 40, 40B, 50, 50A, 50B, 50C, 50D, 50E, 50F, 60, 2200, 2500, 4500, 6500

1754345M1

Clutch Plate
Internal Spline



Fits 204, 205, 302, 304, 30, 30B, 30D, 30E, 40, 40B, 50, 50A, 50B, 50C, 50D, 50E, 50F, 60, 2200, 2500, 4500, 6500

1754394M1

Metal Seal Ring, Large
(3 Required)



Fits 204, 205, 302, 304, 30, 30B, 30D, 30E, 40, 40B, 50, 50A, 50B, 50C, 50D, 50E, 50F, 60, 2200, 2500, 4500, 6500

530718M92

Transmission Pump
For Torque Converter
Transmission



Fits 2200, 30, 40, 50, 30B, 40B, 50A, 50C, 30D, 30E, 40E, 50D, 50E, 60, 2500, 4500 & 6500 Forklift

1754392M1

Trans Pump Gasket



Fits 204, 205, 302, 304, 30, 30B, 30D, 30E, 40, 40B, 50, 50A, 50B, 50C, 50D, 50E, 50F, 60, 2200, 2500, 4500, 6500

884422M1

Transmission Pump Seal



Fits 2200, 30, 40, 50, 30B, 40B, 50A, 50C, 30D, 30E, 40E, 50D, 50E, 60, 2500, 4500 & 6500 Forklift



PTO

Massey Ferguson

899329M1

Replaces 1867820M1
PTO Gear
53 Teeth, 15 Splines



1868532M1

PTO Gear
53 Teeth, 21 Splines



Fits 135, 150, 165, 175, 180, 20, 20C, 230, 235, 245, 255, 265, 270, 275, 282, 283, 285, 290, 30, 31, 40, 40B, 50C, 50D, 50E, 565, 575, 590

834216M1

PTO Seal
For Large PTO Bearing



Fits 230, 235, 245, 1085, 255, 265, 275, 285, 231, 240, 250, 253, 360, 362, 270, 282, 283, 290, 298, 375, 383, 390, 390T, 398, 399, 670, 690, 698, 699

966028M1

PTO Shaft



1870004M92

PTO Housing



Fits 240, 253, 263, 270, 290, 298, 360, 362, 365, 375, 390, 390T, 393, 394S, 396, 398, 399, 670, 690, 698, 699, 30E, 40E, 50H, 50HX, 60H

966026M2

PTO Coupler



966029M2

PTO Counter Shaft



Fits 25, 130

1872279M96

Replaces 1872279M95, 1872279M96, 19870027M92
PTO Valve
For 2 Speed PTO



Fits 240, 253, 263, 270, 290, 298, 360, 362, 365, 375, 390, 390T, 393, 394S, 396, 398, 399, 670, 690, 698, 699, 30E, 40E, 50H, 50HX, 60H

1660288M91

540 RPM PTO Shaft
24.125" Long
21 Drive Splines



Fits 230, 235, 245, 255, 265, 275, 240, 250, 270, 282, 283, 290, 20, 20B, 20C, 20F, 30, 30D, 31, 390, 40, 40B, 40F, 50D, 50E, 50G

195763M1

PTO Seal

Fits TO20, TO30



1860325M1

Replaces 195506M1
PTO Seal
For Small PTO Bearing



Fits 35, 50, 65, 135, 150, 165, 175, 180, 230, 235, 255, 265, 275, 40

532899M1

540 RPM PTO Shaft
24.125" Long
21 & 38 Drive Splines



Fits 265, 275, 270, 290, 360, 375, 390, 390T, 398, 399, 670, 690

Massey Ferguson

REAR AXLE & DIFFERENTIAL

3760665M1

Replaces 888108M1
PTO Cover, L/H



Fits 135, 150, 165, 175, 230, 235, 245, 255, 265, 275, 240, 250, 253, 263, 282, 283, 285, 20, 20F, 30B, 30D, 30E, 40B, 40E, 50E

1870594M92

PTO Fork



Fits 135, 20, 20C, 230, 235, 240, 245, 250, 253, 255, 265, 275, 282, 283, 285, 290, 30B, 30E, 350, 360, 362, 375, 383, 390, 40B, 50E

1672622M94

PTO Lever, Steel



1863502M1

PTO Lever, Aluminum



1877461M1

PTO Lever Ball



Fit 135, 150, 165, 175, 230, 235, 245, 255, 265, 275, 240, 250, 270, 282, 283, 20, 20B, 20C, 20F, 30B, 30E, 40B, 40E, 50E

888108KIT

PTO Shifter Assy

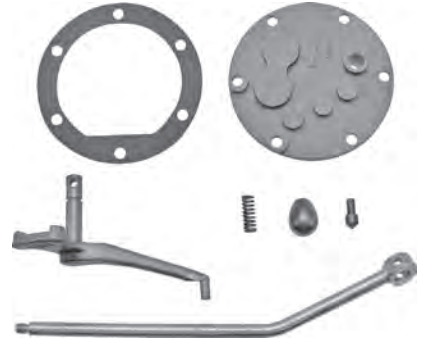

Fits 135, 150, 165, 175, 230, 235, 245, 255, 265, 275, 231, 240, 250, 253, 263, 282, 283, 285, 20, 20F, 30B, 30D, 30E, 40B, 40E, 50E

1871924M1

Pinion Coupling
3 13/16" Long



Fits 230, 235, 245, 231, 240, 250

1683757M91

Ring Gear and Pinion
6 & 37 Teeth, 10" Pinion

Fits 230, 235, 245, 231, 240, 250, 253, 360, 362, 202, 203, 204, 205, 20, 2135



1885317M92

Ring Gear and Pinion
6 & 37 Teeth, 9" Pinion

Fits 35, 50, 135, 20, 2135, 202, 203, 204, 205

825776M1

Replaces 891947M1
Ring Gear Bolt & Nut



Fit 35, 50, 20, 2135, 230, 235, 245, 231, 240, 250, 253, 360, 362, 202, 203, 204, 205, 20C, 30B, 40B, 20D, 30E, 40E

REAR AXLE & BRAKES

Massey Ferguson

892709M91
Replaces 892710M1
 Rear Axle
 For 2 Gear Planetary



Fits 65, 165

1021314M1
 Brake Disc
 7.125" Diameter,
 27 Splines



Fits 135, 150, 165, 175, 180, 203, 204, 205, 302, 304, 30, 3165, 356, 31, 40, 2200, 2500

180004M1
 Rear Lug Nut
 For Tractors with Dry Brakes, 9/16" NF



185400M1
Replaces 825507M1
 Rear Lug Bolt
 For Tractors with Dry Brakes, 9/16" NF



Fits TO20, TO30, TO35, 35, 50, 135, 150, 230, 234, 245, 240, 231, 202, 203, 204, 205, 20, 2135, 2200

764805M91
 Brake Actuator Assy
 7" O.D.



Fits 65, 150, 165, 175, 180, 1080, 765, 33, 333, 44, 444, 85, Super 90, 203, 204, 205, 2200, 30, 302, 3165

1005510M1
 Brake Spring



Fits 65, 135, 150, 165, 175, 178, 180, 203, 205, 302, 304, 2500, 3165, 40, 85, 88, Super 90, 1080, 274, 294, 3050, 333, 444, 5500, 5830, 5860, 5870, 6070, 6500, 6530, 6830, 6860, 6870, 765, 7830, 7860, 7870, 8500, 8830, 8880

1860963M92
 Brake Actuator Assy
 For Wet Brakes



Fits 245, 255, 265, 275, 285, 1085, 250, 270, 283, 290, 360, 375, 383, 390, 393, 398, 670, 690, 698, 699, 20F, 30, 30B, 30D, 30E, 30H, 31, 40, 40B, 40C, 50A, 50C, 50D, 50E, 50H, 60

894782M2
 Rear Axle Seal
 For Tractors With Dry Brakes



Fits 150, 165, 175, 178, 180, 235 Orchard, 245 Orchard, 255, 265, 275, 285, 1080, 1085, 30, 31, 40

180596M1
 Rear Axle Collar
195677M1
 Rear Axle Seal, Outer



195678M1
 Rear Axle Seal, Inner

Fits TO35, 35, 50, 135, 150, 20, 20C, 202, 204, 2135, 2200, 230, 235, 245, 231, 240

1044526M1
Replaces 1805980M1
 Brake Disc
 8.875" Diameter
 For Dry Brakes



Fits 135, 150, 165, 175, 180, 235, 245, 255, 265, 275, 285, 1080, 1085, 30, 31

Massey Ferguson

BRAKES

830480M1

Brake Shoe Set

PRICED AND SOLD AS SET OF 4



Fits 35, 50, 135, 150, 230, 235, 202, 203, 204, 205, 2135, 20

1676387M92

Replaces 3186484M91

Brake Slave Cylinder



Fits 270, 290, 298, 670, 690, 698, 698T, 699, 30E, 30H, 40E, 50D, 50E, 50EX, 50HX, 60H

3383079M5

Brake Master Cylinder



Fits 3050, 3060, 3075, 3095, 3120T, 3125, 3645, 3655, 3670, 3690, 6140, 6150, 6170, 6180, 6190, 6235, 6245, 6255, 6265, 6270, 6280, 6290, 8120, 8140, 8150, 8160, 8210, 8220, 8240, 8250, 8260, 8270, 8280

3477380M92

Brake Slave Cylinder, L/H



Fits 340 (S/N V39467 & Up), 350 (S/N V39467-Later), 355 (S/N V39467-Later), 360 (S/N V39467-Later), 362, 365 (S/N V39467-Later), 372, 375 (S/N V39467-Later), 382, 383 (S/N V39467-Later), 390 (S/N V39467-Later), 390T (S/N V39467-Later), 398 (S/N V39467-Later), 399 (S/N V39467-Later)

3595504M2

Brake Cylinder Assy

Early S/N



Fits 360, 362, 375, 383, 390, 398, 399

1613986M4

Brake Master Cylinder



Fits 2620, 2625, 2640, 2645, 2680, 2685, 2720, 2725, 3050, 3060, 3065, 3070, 3075 (S/N C340006-Later), 3085, 3095 (S/N C280041-Later), 3115, 3120, 3125, 3140, 3630, 3635, 3645, 3650, 3655, 3660 (Bendix with Dynashift), 3670, 3680, 3690, 6110, 6120, 6130, 6140, 6150, 6160, 6170, 6180, 6190, 8110, 8120, 8130, 8140, 8150, 8160

1682767M91

Brake Cylinder Assy



Fits 670, 675, 690, 698, 699

3596785M92

Brake Cylinder Assy

Late S/N



Fits 360, 362, 375, 383, 390, 398, 399

3614780M91

Brake Cylinder Assy



Fits 362, 365, 375, 383, 390, 390T, 393, 396, 398, 399

STEERING, TIE ROD ENDS

Massey Ferguson

180381M91

Replaces 180381M1
Tie Rod End
Front, R/H & L/H



Fits TO20, TO30, 35, 20, 2135, 202, 203, 204, 205

180391M91

Replaces 180391M1
Tie Rod End
Rear, R/H & L/H



Fits TO20, TO30, 35, 20, 2135, 202, 203, 204, 205

180780M92

Tie Rod Assy with Ends
For Swept Back Axle



Fits TO35, 35, 135, 230, 235, 202, 203, 204, 205, 20, 2135

3595181M92

Tie Rod, Complete
For Tractors with Hydrostatic Steering



Fits 240, 253, 263, 360, 362

1692144M1

Replaces 1860565M2
Drag Link End, Front
A: Length 7.750"
B: Diameter .582"

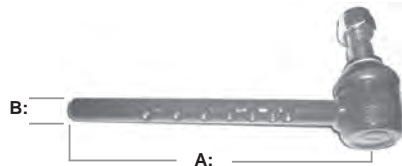

Fits 240, 250, 231, 20D, 20F

1033035M1

Power Steering Cylinder End



Fits 20C, 30B, 30D, 40, 40B, 4500 Forklift,
235 and 245 Orchard, 265, 285, 2200, 70, 80

1048271M91

Tie Rod Tube



1048272M91

Tie Rod End, L/H



1048273M91

Tie Rod End, R/H



1050038M91

Replaces 1050038M1
Power Steering Cylinder End



Fits 230, 245, 20C

1028098M91

Inner Tie Rod, L/H



1028099M91

Inner Tube, L/H



1028262M91

Outer Tie Rod, R/H & L/H



1028264M91

Inner Tube with Ball Joint, R/H



Fits 165, 175, 255, 265, 275, 30, 31, 3165

Massey Ferguson

STEERING, TIE ROD ENDS

1044294M91

Tie Rod End, R/H Outer



1044295M91

Tie Rod End, R/H Inner



1044296M91

Tie Rod Tube and Clamp, R/H



1044297M91

Tie Rod End, L/H Inner



1044298M91

Tie Rod End, L/H Outer



Fits 285

1026382M91

Tie Rod End, Outer R/H & L/H



1026383M91

Tie Rod End, Inner R/H & L/H



Fits 1100, 1130, 1150, 1105, 1135, 1155

3040676M92

Tie Rod End, Outer L/H



3045062M91

Tie Rod End, Outer R/H



3038564M92

Tie Rod End, Outer R/H & L/H

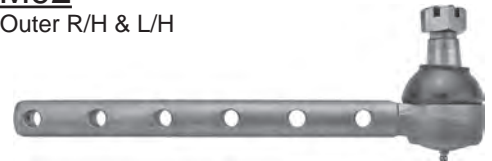

Fits 2745, 2775, 2805

1028266M91

Tie Rod Tube



1028268M91

Tie Rod End, Short



Fits 180, 1080, 1085

STEERING, SPINDLES

Massey Ferguson

3697027M91

Spindle, R/H

- A - 12.687"
- B - 1.762"
- C - 1.796"
- D - 1.250"

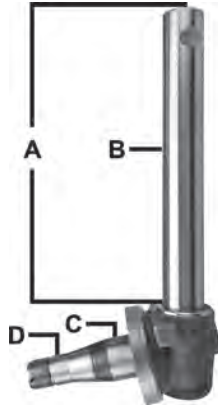

Fits 365 (Up to S/N B18009), 375, 383, 390, 390T, 393, 398, 399

3697030M91

Spindle, L/H

- A - 9.92"
- B - 1.762"
- C - 1.796"
- D - 1.250"

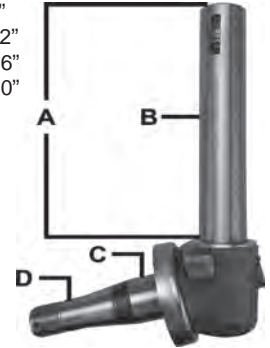

Fits 365 (Up to S/N B18009), 375, 383, 390, 390T, 393, 398, 399

3697028M91

Spindle, L/H

- A - 12.687"
- B - 1.762"
- C - 1.796"
- D - 1.250"

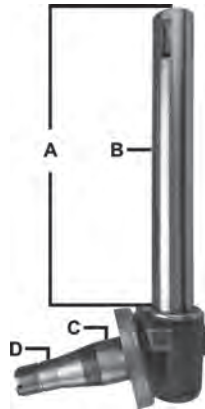

Fits 365 (Up to S/N B18009), 375, 383, 390, 390T, 393, 398, 399

3697031M91

Includes 1696629M93
Spindle, R/H

- A - 8.07"
- B - 1.762"
- C - 1.796"
- D - 1.250"

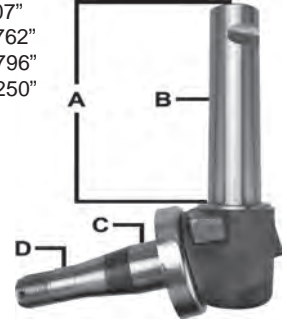

Fits 365 (Up to S/N B18009), 375, 383, 390, 390T, 393, 398, 399

3697029M91

Spindle, R/H

- A - 9.92"
- B - 1.762"
- C - 1.796"
- D - 1.250"

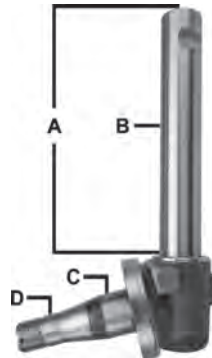

Fits 365 (Up to S/N B18009), 375, 383, 390, 390T, 393, 398, 399

3697032M91

Includes 1696629M93
Spindle, L/H

- A - 8.07"
- B - 1.762"
- C - 1.796"
- D - 1.250"

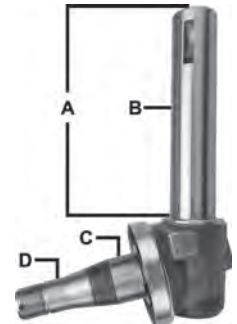

Fits 365 (Up to S/N B18009), 375, 383, 390, 390T, 393, 398, 399

Massey Ferguson

STEERING, STEERING SECTOR PARTS

180576M1

Steering Wheel
Metal Spoke Type

Fits TO20, TO30, 35, 50,
135, 2135, 20, 202, 203,
204, 205



1691798M1

Steering Wheel
Splined Type

Fits 231, 240, 250, 253,
360, 362, 20D, 30E,
40E



772064M1

Steering Wheel

Fits 165, 175, 230, 235,
245, 255, 265, 275, 285,
30, 31, 40, 3165

Power



1751666M1

Wormshaft, Power Steering
Fits 35, 202, 203, 204, 205

1031341M91

Wormshaft, Power Steering
Fits 135, 20, 2135 Industrial

180549M1

Steering Bearing



180526M1

Steering Bearing Race



Fits 35, 135, 20, 2135, 202, 203, 204, 205

195592M1

Steering Wheel Nut
Dome Style

Fits TO20, TO30, 35, 50, 20, 2135, 202, 203,
204, 205



Manual



180538M91

Wormshaft, Manual Steering
Fits 35, 202, 203, 204, 205

1031344M91

Wormshaft, Manual Steering
Fits 135, 20, 2135

1876967M91

Wormshaft, Manual Steering
Fits 235

195872M1

Needle Bearing



196076M1

Replaces 1677724M1,
832775M1
Needle Bearing



Fits 35, 135, 202, 203, 204, 205, 20, 2135

1751702M1

Upper Seal



1751703M1

Replaces 1097182M1
Lower Seal
For Power Steering Adapter



1751676M1

Bearing and Races



1751687M1

O-Ring (2 Required)



1751691M1

Spring Washer



Fits 35, 135, 20, 2135

1850526M91

Includes 1850527M91
Bearing and Race
For Steering Sector
Fits 50, 65



STEERING, SECTOR PARTS, & STEERING SECTORS

Massey Ferguson

1751643M1

Power Steering Cover Plate



1751644M1

Power Steering Guide



1019500M91

Power Steering Cylinder Adapter

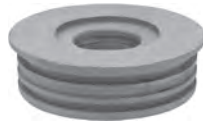

1751701M1

Replaces **470009**,
471466, **566401**
Seal



1751661M1

Power Steering Piston



1751663M1

Ring
2 Required



1751664M1

Power Steering Guide



1041936M1

Power Steering Pin



1041938M1

Power Steering Rod



1041937M1

Power Steering Rack



Fits 35, 135, 20, 2135

180561M1

O-Ring for Steering Sector



Fits 35, 135, 20, 2135, 202, 203, 204, 205

1673663M91

Manual Steering Sector
With Arms



Fits 231, 240, 250, 20D, 30E, 40E
(Will Also Work on 35, 50, 20, 135,
2135, 235 With Dash Modification,
202, 203, 204, 205 By Ordering 2
Gear Shift Cup and Nut and Steering
Wheel) (See Below)

827690M1

Gear Shift Cup and Nut



Fits 231, 240, 250, 20D, 30E, 40E

1691798M1

Steering Wheel, Splined Type



Fits 231, 240, 250, 20D, 30E, 40E

SRK632AA

Steering Shaft Repair Kit
For Tractors With Power
Steering



Fits 35, 135, 202, 203, 204, 205, 20, 2135

Massey Ferguson

STEERING, P/S PUMPS

544443M91

Replaces 1076742M91, 182493M92, 191423M92, 191426M91

Power Steering Pump
With Continental Z129, Z134, and Z145 Gasoline Engines

Fits 35, 50, 65, 135, 150, 202, 203, 204, 205, 20, 2135, 230, 235, 245, 2200, 2500, 302, 304



1696665M91

Replaces 3763744M91
Power Steering Pump

Fits 283 UK, 362, 265, 375, 383, 390, 390T, 398 S/N <B18008



773126M92

Power Steering Pump

Fits 35, 50, 135, 150, 230, 235, 245, 240, 250, 20, 20C, 20E, 20F, 30B, 30E, 40E, 40B, 202, 203, 204, 205, 2135



3774649M91

Replaces 1666726M93, 1666727M92, 1808289M91
Power Steering Pump

Fits 165 UK, 270, 283, 290, 670, 690



523090M91

Power Steering Pump
For 4.203 Diesel Engine

Fits 65, 165, 255, 302, 304, 3165, 30, 40B, 50, 50A

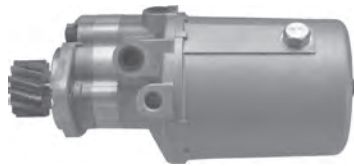

3900440M92

Replaces 3763744M91, 1691155M92
Power Steering Pump

Fits 270, 275 UK, 283, 290, 670, 690



523092M91

Power Steering Pump
For 4.236 Diesel Engine

Fits 175, 180, 255, 265, 275, 30, 31, 50C, 50D, 6500



897147M95

Replaces 897146M94, 1662243M91
Power Steering Pump

Fits 165 UK, 175 UK, 178 UK, 261, 265S, 285S, 275 UK, 282, 290



523089M91

Power Steering Pump
For 4.318 Engine

Fits 1080, 1085, 285



3772715M91

Replaces 3774042M91
Power Steering Pump

Fits 231



3774614M91

Replaces 1695922M91
Power Steering Pump
Location of line ports may be different than original. Adapters may be needed.

Fits 240, 253, 263, 360, 20F, 40E



STEERING, P/S CYLINDERS

Massey Ferguson

1749201M91

Power Steering Cylinder
With Replaceable Ends



Fits 230, 245

1749245M91

Replaces 1749246M91

Power Steering Cylinder
Works For Both 2 and 4 Port
Cylinders



Fits 255, 265, 275, 285 S/N 9A349239 And Up With Dual
Power Steering Cylinders

3401240M91

Power Steering Cylinder, L/H

3401241M91

Power Steering Cylinder, R/H



Fit 231, 240, 250

1749213M91

**Replaces 1749214M91,
532225M91, 532226M91**

Power Steering Cylinder
Works For Left or Right Side



Fits 20C, 30B, 40B, 30D, 4500 Forklift, (235, 245
Orchard)

3401553M92

Power Steering Cylinder
Hydrostatic Steering
R/H & L/H

0.715" Diameter
at Small End of Taper

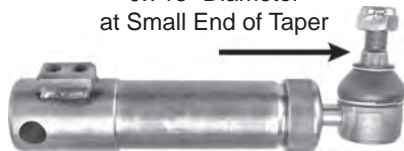

Fits 231, 240, 250, 253, 360, 362, 20D, 30E, 40E

3401274M91

Replaces 3401299M91

Power Steering Cylinder
Works For Left or Right Side



Fits 20F, 30E, 30H, 40H

3401285M93

Power Steering Cylinder

0.570" Diameter at
Small End of Taper

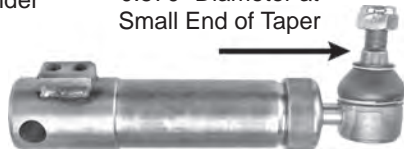

Fits 240, 250

519283M91

Replaces 519284M91

Power Steering Cylinder
Works For Left or Right Side



Fits 40 Industrial

Massey Ferguson

STEERING, P/S CYLINDERS & PARTS

1605121M92

Replaces 1605121M1, 3773711M1,
3773711M91, 532193M1, 532193M91
Power Steering Cylinder



Fits (265, 255, 275, 285, Prior to S/N 9A349239), 261, 271, 281, 283, 290, 690, 270, 670, 261, 50E, 50F, 50H, 50HX, 60H

7003936M91

Connector Fitting
For Power Steering Cylinder
(Short One)



3029953M91

Connector Fitting
For Power Steering Cylinder
(Long One)



Fits 231, 240

3186320M92

Replaces 1853466M93, 3773740M91
Power Steering Cylinder



Fits 165 UK, 175 UK, 265S, 285S, 275 UK, 282, 290 UK

3029957M91

Power Steering Hose



Fits 231, 240P

3763762M91

Replaces 3773713M91
Power Steering Cylinder



Fits 375, 383, 390, 390T, 393, 398, 399, all 11/1994 and Up
Heavy Duty 2WD

1672420M92

Power Steering Hose, L/H
31" Long

1672421M92

Power Steering Hose, R/H
27" Long

Fits 231S, 240, 240S, 250, 20E





STEERING, P/S CYLINDER PARTS & P/S KITS

Massey Ferguson

1606882M3

Power Steering Cylinder Shaft



Fits 255, 265, 275, 285

3314663M91

Power Steering Cylinder Kit

Used on 3401240M91
3401241M91 Cylinders



Fits 20E, 240

1885795M1

Steering Cylinder Shaft



Fits 165 UK, 175 UK, 282

3904170M1

Power Steering Cylinder Seal Kit

Used on 3401553M92
3401285M93 Cylinders



Fits 231, 240, 253, 263, 362

1027231M91

Power Steering Cylinder Shaft and Piston



Fits 165, 175, 3165, 30, 31

1749798EARLY

Power Steering Cylinder Seal Kit

Fits 230, 245 (Prior to 9A282529)

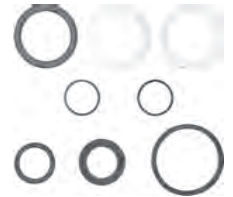

3404472M91

Power Steering Cylinder Rod

0.570"
Diameter at
Small End of
Taper

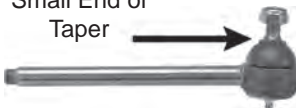

Fits 231, 240, 250, 20D

830860M92

Power Steering Cylinder Seal Kit

Fits 50, 65, 150, 165, 175, 3165, 30, 31

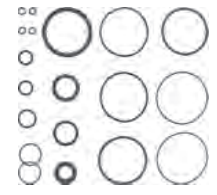

3443036M91

Power Steering Cylinder Rod

0.715"
Diameter at
Small End of
Taper

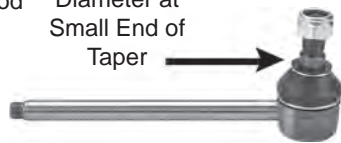

Fits 20F, 30E, 360, 362,
40E, 240 SN N01001>

1606890M91

Power Steering Cylinder Seal Kit
For Tractors With Single Power
Steering Cylinders

Fits 255, 265, 275, 285, 261,
270, 271, 281, 282, 283, 670,
690, 50E, 50F, 50H.



1033035M1

Power Steering Cylinder End

Fits 20C, 30B, 30D, 40, 40B, 4500 Forklift,
235 & 245 Orchard, 265, 285, 2200, 70, 80



1050038M91

Power Steering Cylinder End

Fits 230, 245, 20C



1749798M91

Power Steering Cylinder Seal Kit

Fits 230, 245 (After 9A282529),
255, 265, 275, 285 (With Twin
Power Steering Cylinders)

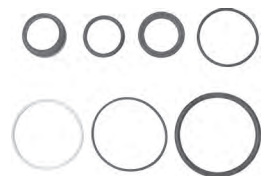



Massey Ferguson

STEERING, CONTROL VALVES

3186463M95

Power Steering Control Valve



Fits 231, 240, 250, 20D, 30E, 40E

3186321M92

Power Steering Control Valve



Fits 231S, 165 UK, 175 UK, 178UK, 275 UK, 265S, 285S, 290 UK

532192M92

Steering Orbital Motor



Fits 255, 265, 275

1695445M91

Replaces 1695444M91

Steering Orbital Motor



Fits 240, 253, 263, 360, 362, 365, 261, 271, 375, 383, 390, 390T, 393, 398, 399, 4225, 4233, 4235, 4240, 4243, 4253, 4245, 4270, 4263

520348M91

Steering Orbital Motor



Fits 40 IND

544387M91

Steering Motor
Spline Type Shaft



Fits 230, 245, 20C, 30B, 40B

1051699M91

Steering Motor
Roll Pin Type Shaft



Fits 255, 265, 275, 285, 290, 298

MF11100B

Steering Motor
With Splined/Threaded Shaft
This is an Economical Option
to Replace Ross/Hydroglide
Units In Most Applications
(With Line Modification)



Fits 230, 245, 20C, 30B, 40B

MF11125B

Steering Motor
Roll Pin Type Shaft
This is an Economical Option
to Replace Ross/Hydroglide
Units In Most Applications
(With Line Modification)



Fits 255, 265, 275, 285, 290, 298



STEERING, CONTROL VALVES & MISC

Massey Ferguson

HG500007

Replaces 837253M91

Steering Control Valve
Upper Seal Kit For Ross,
TRW, and Hydraguide
Units



Fits 230, 245, 255, 265, 275, 285, 2675, 2705, 2745, 2775,
2805, 20C

737181M1

Steering Sector Bracket



Fits 150, 165, 175, 255, 3165, 30, 40B

1686590M91

Steering Column



Fits 265S, 270, 275 UK, 283, 285S, 290, 298, 50E

3599941M91

Steering Column



Fits 240, 231S, 241S, 253, 263

MFPSKIT

**Power Steering
Add-On Kit**



Fits 35, 135, 20, 2135 202, 203, 204, 205 (3 Cylinder
Tractors Only)

Massey Ferguson

FRONT AXLE, AXLE PARTS & SUPPORTS

183219M91

Front Axle with Bushing



183221M1

Front Axle Pin
1.750" Dia, 5.500" Long



182850M1

Front Axle Bushing



Fits TO20, TO30, 35, 50, 20, 2135, 230, 235, 20, 2135

897235M1

Steering Shaft Bushing
2.000" O.D., 1.876" I.D., 1.500" Long



Fits 165, 175, 255, 265, 275, 285, 270, 282, 283, 290, 298, 392, 50E, 50H, 6500H, 670, 690, 698, 699, 8530F

897712M2

Front Axle Bushing



Fits 165, 175, 180, 255, 265, 275, 285, 30, 31, 40, 3165

544438M1

Front Axle Pin



Fits 230, 245

898016M3

Front Axle Pin



898017M1

Washer 1 29/32" x 2 5/8" x 7/64"

898018M2

Shim .28" Thick

898019M2

Shim .34" Thick



898020M2

Shim .39" Thick

882868M2

Shim .46" Thick

882869M2

Shim .51" Thick

Fits 165, 175, 255, 265, 275, 285, 30, 3165, 283, 290, 383, 390

1688611M91

Front Support
1.890" Center Hole I.D.
1.650" Bushing I.D.
(With Bushings)



Fits 240

1670974M96

Front Support
2.060" Center Hole I.D.
(Without Bushings)

Fits 230, 245

1870287M95

Replaces 1684301M91

Front Axle Support
(For Tractors with
4.236 and 4.248
Engines)
(Will Not Fit 4.203 Engines)



Fits 255, 265, 275

506913M91

Front Axle Pivot Bracket



Fits 50, 65, 50, 150

505870M91

Front Axle Pivot Bracket, Front



505875M91

Front Axle Pivot Bracket, Rear



Fits 180

FRONT AXLE, STEERING ARMS & HUBS

Massey Ferguson

544435M4
Steering Arm, L/H



Fits 230, 245

532781M92
Front Hub



Fits 1080, 1085, 285

534155M91
Steering Arm
43 Splines



Fits 165, 175, 3165

1625298M2
Front Hub



Fits 290, 298, 375, 383, 390, 390T,
398, 399, 670, 690, 698, 699

514285M1
Upper Steering Arm



Fits 165, 175, 30, 31, 3165

519278M91
Front Hub



Fits 135, 150, 165, 175, 230, 235, 245,
255, 265, 275

194567M92
Steering Arm
43 Splines



Fits 165, 175, 3165

898346M93
Front Hub
With Lug Bolts, Nut, and Cap



Fits 165 UK, 253, 255 Export, 275 UK,
282 MEX, 283, 290, 360, 362, 375,
383, (390, 390T, 393, 398, All UK tractors
With 348mm axle), 399, 670

578406M91
Steering Arm
42 Splines



Fits 255, 265, 275, 285

194621M1
Front Hub Cap



Fits 135, 150, 165, 175, 230, 235, 245, 255, 265

518611M1
Front Lug Bolt



Fits 135, 150, 165, 175, 230, 235, 245, 255, 265, 275



Massey Ferguson

HYDRAULICS, HYDRAULIC PUMPS

184473M93

Replaces 183005M91
Main Hyd Pump



Fits 35, 40, 50, 65, 202, 203, 204, 205, 302

1686766M91

**Replaces 531607M93,
526099M93**
Aux Hydraulic Pump



Fits 135, 150, 165, 175, 180, 230, 235, 245, 1080, 1085,
255, 265, 275, 285, 253, 360, 362, 270, 282, 283,451

519343M96

**Replaces 897486M91,
194698M91, 1684582M92,
884302M91**
Main Hyd Pump, 10 Spline Shaft

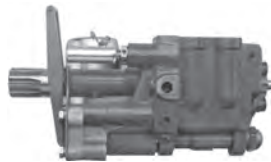

Fits 135, 150, 165, 175, 180

886821M94

Aux Hydraulic Pump



Fits 135, 150, 165, 175, 20C, 235, 245, 255, 265, 275, 30,
31, 40B, 50C, 50D

1684583M92

**Replaces 1868965M92,
535087M91**
Main Hyd Pump
21 Spline Shaft



Fits 135, 150, 165, 175, 230, 235, 245, 20, 30, 31

3701005M91

**Replaces 3597706M91,
3774612M91**
Steering / Auxiliary Pump



Fits 265S, 285S, 362, 365, 375, 383, 390, 390T, 398, 399

3761324M91

Replaces 3598260M91
Main Hyd Pump
21 Spline Shaft



Fits 240, 253, 263, 271, 281, 283, 290, 362, 365, 375, 383,
390, 390T, 451, 20F

1672251M92

**Replaces 1868439M98,
1872449M96**
Hydraulic Pump



Fits 231, 245, 255, 265, 275, 283, 298, 670, 690, 698, 699,
30, 40, 20C, 30B, 50C, 50E

3597420M91

Hydraulic Pump



Fits 399 with 6.354.4 Engine (With Cold Start Valve)



HYDRAULICS, HYDRAULIC PUMPS

Massey Ferguson

3816909M91

Replaces 3701006M91, 3800194M91, 510665120

Tandem Hydraulic Pump



Fits 4225, 4225HV, 4235, 4235 (USA), 4235HV, 4235HV (USA), 4240, 4245, 4245HV, 4255, 4255HV, 4260, 4265, 4270, 4325, 4325HV, 4335, 4335HV, 4345, 4345HV, 4355, 4355HV, 4360

3816914M91

Replaces 0510525065
Tandem Hydraulic Pump



Fits 4200, 4225, 4225HV, 4235, 4235 (USA), 4235HV, 4235HV (USA), 4240, 4245, 4245HV, 4255, 4255HV, 4260, 4265, 4270

3816910M91

Replaces 3800195M91, 510665120

Tandem Hydraulic Pump



Fits 4200, 4215, 4220, 4225, 4225HV, 4235, 4235 (USA), 4235HV, 4235HV (USA), 4240, 4245, 4245HV, 4255, 4255HV, 4260, 4265, 4315, 4320, 4325, 4325HV, 4335, 4335HV, 4345, 4345HV, 4355, 4355HV, 4365

3382280M1

Replaces 3616060M1, 510665389

Tandem Hydraulic Pump



Fits 3050, 3060, 3065, 3070, 3075, 3080, 3085, 3090, 3095, 3115, 3120, 3125, 6110, 6120, 6130, 6140, 6150, 6160, 6170, 6180, 6190, 6235, 6235HV, 6245, 6245HV, 6255, 6255HV, 6260, 6265, 6270, 6280, 6290

3816911M91

Replaces 3800196M91, 0510765044

Tandem Hydraulic Pump



Fits 4200, 4215, 4220, 4225, 4225HV, 4235, 4235 (USA), 4235HV, 4235HV (USA), 4240, 4245, 4245HV, 4255, 4255HV, 4260, 4265, 4300, 4315, 4320, 4325, 4325HV, 4335, 4335HV, 4345, 4345HV, 4355, 4355HV, 4365

Massey Ferguson

HYDRAULICS, HYDRAULIC PUMP PARTS

181163M1

Control Valve



Fits TE20, TO20, TO30

181087M91

Hydraulic Pump
Safety Valve



Fits TE20, TO20, TO30

181073M91

Valve Chamber, R/H
Without Valves



181075M91

Valve Chamber, L/H
Without Valves

Fits TE20, TO20, TO30

181073M91WV

Valve Chamber, R/H
With Valves



181075M91WV

Valve Chamber, L/H
With Valves

Fits TE20, TO20, TO30

890675M1

Piston



Fits TE20, TO20, TO30

181066M1

Cam Block



Fits TE20, TO20, TO30

181086M1

Valve Chamber Plug



Fits TE20, TO20, TO30

VALVEKIT01

Valve Chamber Repair Kit



Fits TE20, TO20, TO30

PUMPKIT01

Hydraulic Pump
Repair Kit



Fits TE20, TO20, TO30

HYDRAULICS, HYDRAULIC PUMP PARTS

Massey Ferguson

1860038M1

Hydraulic Pump Piston
.980" Dia



897493M1

Hydraulic Pump Piston Ring
.980" Dia



Fits 135, 150, 165, 175, 180, 230, 235, 245, 1080, 1085, 255, 265, 275, 285, 231, 240, 250, 253, 360, 362, 20D, 30E, 40E, 270, 282, 283, 290, 298

1865012M1

Replaces **1664491M1**
Hydraulic Pump Bushing
Front & Rear



Fits 135, 150, 165, 175, 180, 230, 235, 245, 1080, 1085, 255, 265, 275, 285, 231, 240, 250, 253, 360, 362, 20D, 30E, 40E, 270, 282, 283, 290, 298

1868734M1

Replaces **1868734M1K**
Valve Chamber Complete with Valves



Fits 135, 150, 165, 175, 180

883402M92

Safety Valve
2550 PSI



884747M92

Safety Valve
2750 PSI

Fits 135, 150, 165, 175, 180, 230, 235, 245, 1080, 1085, 255, 265, 275, 285, 231, 240, 250, 253, 360, 362, 20D, 30E, 40E, 270, 282, 283, 290, 298

888702M3

Replaces **888701M1, 1868435M1, 1868435M2, 1868435M93, 1868435M3VA**
Valve Chamber Complete with Valves



Fits 231, 240, 250, 253, 360, 362, 270, 282, 283, 290, 298, 165, 175, 180

521451M1

Hydraulic Pump Filter



Fits 35, 50, 65, 135, 150, 165, 175, 180, 202, 203, 204, 205, 302, 304, 20, 2135, 30, 31, 40, 3165

180924M2

Replaces **180924M1**
Front Cam Block
With Flange



180925M2

Replaces **180925M1**
Rear Cam Block
Without Flange



1000251M1

Hydraulic Pump Shaft Bearing



180933M1

Hyd Pump Cam Follower



Fits 35, 50, 65, 135, 150, 165, 175, 180, 230, 235, 245, 1080, 1085, 255, 265, 275, 285, 231, 240, 250, 253, 360, 362, 270, 282, 283, 290, 298, 375, 383, 390, 390T, 398, 399, 550, 565, 575, 590, 595, 670, 690, 698, 699, 202, 203, 204, 205, 302, 304, 20, 2135, 20C, 30, 30B, 40B, 20D, 30E, 40E, 30, 31, 40, 3165, 50, 50A, 50C

1687042M1

Hydraulic Pump Filter

Fits 230, 235, 245, 1080, 1085, 255, 265, 275, 285, 231, 240, 250, 253, 360, 362, 20C, 30B, 40B, 20D, 30E, 40E

185555M1

Bowl & Cap Kit
For Hyd Pump Filter



Fits 35, 50, 65, 135, 150, 165, 175, 180, 202, 203, 204, 205, 302, 304, 20, 2135, 30, 31, 40, 3165

897504M1

Pin & Roller Kit



898202M1

Lever Roller



Fits 135, 150, 165, 175, 180, 20, 2135, 30, 31, 40, 3165

Massey Ferguson

HYDRAULICS, HYDRAULIC PUMP PARTS

897516M91

Lever with Roller



Fits 35, 150, 165, 175, 180, 20, 2135, 30, 31, 40, 3165

189427M92

Hyd Pump Valve Assy



Fits TO35, 35, 40, 50, 65, 202, 203, 204, 205, 302, 304, 85, Super 90

1868471M1

Lever with Roller



Fits 230, 235, 245, 255, 265, 275, 231, 240, 250, 270, 282, 283, 20C, 30B, 40B, 20D, 30E, 40E

897507M92

Control Valve Assy
Early Style



Fits 135, 150, 165, 175, 180, 202, 203, 204, 205, 2135, 2200, 30, 302, 304, 3165, 40, 50

894906M91

Hydraulic Pump O-Ring Kit

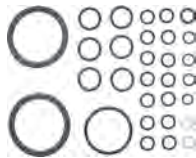

Fits 35, 50, 65, 302, 304, 255, 265, 275

1681789M91

Control Valve Assy
7.5" Long



Fits 135, 150, 165, 175, 20C, 20D, 20E, 20F, 230, 231, 235, 240, 240P, 245, 250, 253, 255, 265, 270, 275, 283, 285, 290, 298, 30, 30B, 30D, 30E, 31, 350, 355, 360, 362, 365, 375, 383, 390, 390T, 392S, 393, 398, 399, 40, 40B, 40E, 50C, 50D, 50E, 550, 565, 575, 590, 595, 670, 675, 690, 698, 698T, 699

1810467M91

Hydraulic Pump O-Ring Kit

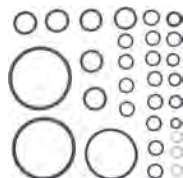

Fits 135, 150, 165, 175, 180, 230, 235, 245, 255, 265, 275, 285, 1080, 1085

1870763M92

Control Valve Assy
Late Style, 7.75" Long



Fits 230, 235, 245, 255, 265, 275, 282, 20C, 30, 31, 30B, 30E, 40B, 50C, 50E

1810684M92

O-Ring Kit with Gaskets

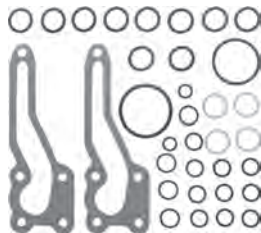

Fits 135, 150, 165, 175, 180, 255, 265, 275, 30, 31, 40, 3165

1810680M91

O-Ring Kit with Gaskets

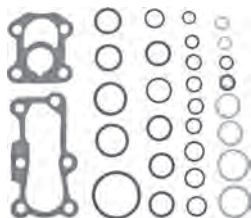

Fits 230, 235, 245, 255, 265, 275, 1080, 1085, 285, 231, 240, 250, 253, 360, 362, 270, 282, 283, 290, 298, 20D, 30E, 40E

1862486M96

Control Valve Assy
Late Style, 8.5" Long



Fits 135, 150, 165, 175, 180, 202, 203, 204, 205, 2135, 2200, 30, 302, 304, 3165, 40, 50



HYDRAULICS, LIFT TOP PARTS

Massey Ferguson

184443M91

Hydraulic Lift Piston
3" Diameter, 3 Ring



Fits 35, 50, 65, 202, 203, 204, 205, 302, 304

897564M1

Hyd Lift Piston Rings
For 3 1/8" Piston



Fits 135, 150, 165, 175, 180, 230, 235, 245, 255, 265, 275, 231, 240, 250, 20, 2135, 20C, 30B, 40B, 20D, 30E, 40E, 30, 31, 40, 3165

897561M91

Hydraulic Lift Piston
3 1/8" Diameter, 3 Ring



Fits 135, 150, 165, 175, 180, 230, 235, 245, 285, 255, 265, 275, 20D, 30E, 40E

897597M1

Hyd Lift Piston Rings
For 3 3/8" Piston



Fits 135, 150, 165, 175, 180, 230, 235, 245, 255, 265, 275, 231, 240, 250, 20, 2135, 20C, 30B, 40B, 20D, 30E, 40E, 30, 31, 40, 3165, 1080, 1085, 285

1665737M91

Replaces 1665740M1
Hydraulic Lift Piston
3 1/8" Diameter, 1 Groove



Fits 135, 150, 165, 175, 180, 230, 235, 245, 255, 265, 275, 231, 240, 250, 20C, 30B, 40B, 20D, 30E, 40E

2528202K1

Hyd Lift Piston O-Ring
For 3 3/8" Piston



2528201K1

Hyd Lift Piston Ring Teflon Seal
For 3 3/8" Piston



Fit 135, 150, 165, 175, 180, 230, 235, 245, 255, 265, 275, 285, 1080, 1085, 270, 282, 283, 290, 298, 20C, 30B, 40B, 20D, 30E, 40E, 30, 40, 3165

899595M91

Hydraulic Lift Piston
3 3/8" Diameter, 3 Ring



Fits 135, 150, 165, 175, 180, 230, 235, 245, 255, 265, 275, 285, 1080, 1085, 20C, 30B, 40B

2528204K1

Hyd Lift Piston O-Ring
For 3 1/8" Piston



2528203K1

Hyd Lift Piston Ring Teflon Seal
For 3 1/8" Piston



Fits 135, 150, 165, 175, 180, 230, 235, 245, 255, 265, 275, 231, 240, 250, 20C, 30B, 40B, 20D, 30E

1665738M91

Replaces 1665739M1
Hydraulic Lift Piston
3 3/8" Diameter, 1 Groove



Fits 135, 150, 165, 175, 180, 230, 235, 245, 255, 265, 275, 285, 1080, 1085, 270, 282, 283, 290, 298, 20C, 30B, 40B, 20D, 30E, 40E, 30, 31, 40, 3165

Massey Ferguson

HYDRAULICS, LIFT TOP PARTS

897560M3

Hydraulic Lift Cylinder
3 1/8" Diameter



Fits 135, 150, 165, 175, 180, 230, 235, 245, 255, 265, 275, 231, 240, 250, 20, 2135, 20C, 30B, 40B, 20D, 30E, 40E, 30, 31, 40, 3165

1671082M1

Hydraulic Lift Cylinder
3 3/8" Diameter



Fits 135, 150, 165, 175, 180, 230, 235, 245, 255, 265, 275, 231, 240, 250, 20, 2135, 20C, 30B, 40B, 20D, 30E, 40E, 30, 31, 40, 3165, 1080, 1085, 285

887654M1

Draft Spring Rubber Boot



Fits F40, MH50, TO35, 135, 150, 165, 175, 20, 20C, 20D, 20F, 202, 203, 204, 205, 2135, 220, 2200, 230, 235, 240, 245, 250, 2500, 255, 265, 275, 283, 285, 290, 298, 360, 365, 375, 383, 390, 392, 393, 396, 398, 399, 670, 690, 698, 699, 30, 30B, 30D, 30E, 30H, 302, 304, 31, 3165, 320, 35, 356, 40, 40B, 40E, 4500, 50, 50A, 50C, 50D, 60, 65, 6500, 85, 88, Super 90

1870341M92

Position Control Lever



1870340M92

Draft Control Lever



Fits 230, 235, 245, 255, 265, 275, 231, 240, 250, 270, 282, 283, 290, 298

180908M1

Lift Top Blank Off Plate



Fits F40, MH50, TO35, 135, 150, 165, 175, 20, 20C, 20D, 20F, 202, 203, 204, 205, 2135, 220, 2200, 230, 235, 240, 245, 250, 2500, 255, 265, 275, 283, 285, 290, 298, 360, 365, 375, 383, 390, 392, 393, 396, 398, 399, 670, 690, 698, 699, 30, 30B, 30D, 30E, 30H, 302, 304, 31, 3165, 320, 35, 356, 40, 40B, 40E, 4500, 50, 50A, 50C, 50D, 60, 65, 6500, 85, 88, Super 90 1080, 1085

1860403M1

Replaces 181042M1
Draft Control Knob



Fits 35, 135, 150, 165, 175, 230, 231, 235, 240, 245, 250, 253, 255, 261, 265, 270, 271, 275, 282, 283, 285, 290, 298, 471, 698, 20, 20F, 20C, 20D, 30, 30B, 30E, 40, 40B, 40E, 50C, 50D, 50E



HYDRAULICS, LIFT TOP PARTS

Massey Ferguson

1870219M93
Replaces 899277M91
 Pressure Control Shaft



1870243M92
 Draft Control Shaft



Fits 135, 150, 165, 175, 230, 235, 240, 245, 250, 253, 255, 265, 270, 275, 282, 283, 285, 290, 298, 360, 362, 375, 383, 390, 390T, 392S, 393, 398, 399, 690, 20, 20F, 20C, 20D, 30, 30B, 30E, 40, 40B, 40E, 50C, 50D, 50E

1872648M93
Replaces 1884877M93
 Lift Response Plate



1662278M2
 Response Lever



898208M2
 Response Control Shaft



1668053M1
 Response Cover



514184M1
Replaces 193400M1
 Hydraulic Dip Stick



Fits 135, 150, 165, 175, 230, 235, 245, 255, 265, 275, 20, 20F, 231, 240P, 253, 30E, 360, 362, 383, 392S, 40E, 50E

Massey Ferguson

HYDRAULICS, REMOTE KITS & HITCH

REMOTEKIT01

Single Hyd Remote Kit

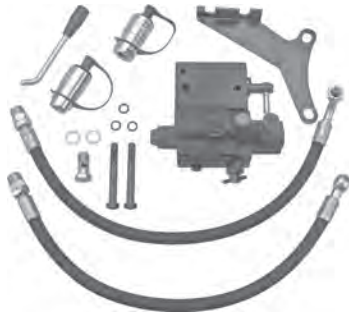

Fits 35, 50, 65, 135, 150, 165, 175, 230, 235, 245, 255, 265, 275, 240, 250, 253, 262, 270, 282, 283, 290

1660438M92

Leveling Assy, R/H

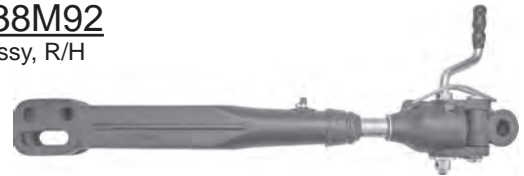

1863888M91

Leveling Assy, L/H



Fits 255, 265, 275, 285, 1080, 1085, 270, 282, 283, 290, 298

1660373M92

Leveling Assy, R/H



1660372M91

Leveling Assy, L/H



Fits 35, 50, 20, 135, 150, 2135, 230, 235, 245, 231, 240, 250, 202, 203, 204, 205, 20C, 30B, 40B, 20D, 30E, 40E

49A40R

Stabilizer Kit



Fits TO20, TO30, TO35, 35, F40, 50

897649M95

Leveling Assy, R/H
1 Hole in Fork



897655M91

Leveling Assy, L/H
1 Hole in Fork



Fits 165, 175, 180, 255, 265, 275, 253, 360, 362, 30, 31, 40, 3165

510584M1

Replaces 182632M91, 182633M91, 510584M91, 510855M91, 510584M92

Lift Arm, R/H & L/H
32 3/4" Center to Center, CAT I
5/8" Thick



Fits 135, 150, 20, 2135

510584LONG

Lift Arm, R/H & L/H
34 1/2" Long, Cat I
5/8" Thick



Fits 35, 50, 20, 2135, 202, 203, 204, 205, 20, 2135



HITCH

Massey Ferguson

531858M92

Lower Lift Arm, R/H

531859M92

Lower Lift Arm, L/H



**CAT I on Implement End
CAT II on Tractor End**

Fits 230, 235, 245, 20C, 30B

886451M93

Lift Arm, R/H or L/H
39" Center to Center
CAT II



Fits 165, 175, 180, 255, 265, 275, 253, 360, 362, 30, 31, 40, 3165

1869289M91

Lift Arm, R/H or L/H
35" Center to Center
CAT II



Fits 231, 240, 250, 20C, 30B, 40B, 20D, 30E, 40E

1660262M93

Lift Arm, R/H
39" Center to Center
Heavy Duty CAT II

1660263M93

Lift Arm, L/H
39" Center to Center
Heavy Duty CAT II



Fits 255, 265, 275, 1080, 1085, 255, 265, 275, 285, 270, 282, 283, 290, 298

184377M1

Check Chain Assy



Fits 35, 50, 65, 135, 150, 230, 235, 245, 231, 240, 250, 203, 205, 302, 304, 20D, 20F, 30E, 40E

893410M1

Check Chain Assy



Fits 165, 175, 255, 265, 275, 253, 270, 282, 283, 290, 350, 355, 360, 362, 365, 375, 383, 390, 390T, 40E, 50E, 670, 690, 20F, 30E

1867851M3

Lower Link Shaft



Fits 20, 20C, 20D, 230, 235, 245, 240, 231

DRAWBARKIT01

Drawbar & Bracket Assy



Fits 135, 150, 165, 175, 230, 235, 245, 255, 265, 275, 231, 240, 250, 253, 263, 270, 282, 283, 285, 20, 20F, 30B, 30D, 30E, 40B, 40E, 50E

531468M1

Drawbar

32.75" Long, 2.00" Wide, 1.25" Thick



Fits 35, 50, 65, 135, 150, 165, 20C, 230, 235, 245, 255, 265, 275, 30B, 40B, 202, 203, 204, 205

Massey Ferguson

SHEET METAL

998667M91
Nose Cone Assy



512953M91
Hood

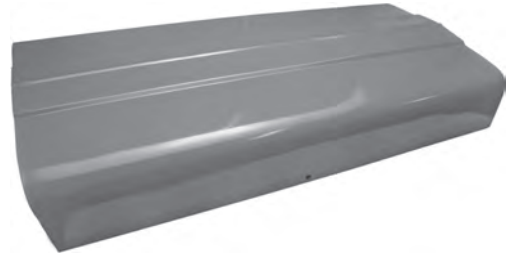

883159M1
Nose Screen

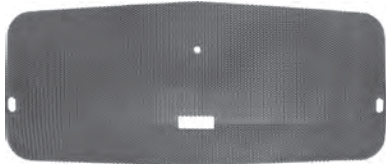

Fits 135, 20, 2135

1860156M1
Grille Bar



511918M91
Long Side Panel, L/H



Fits 135, 150, 165, 175, 180, 20, 2135, 30, 31, 40, 3165

511919M92
Long Side Panel, R/H



Fit 135, 20, 2135

963810KIT
Grille and Door



510457M2
Grille Side Panel, R/H

529672M1
Grille Knob



510458M2
Grille Side Panel, L/H

Fits 135, 20, 2135



Fits 135, 20, 2135

506319KIT
Grille and Door



529672M1
Grille Knob



194147M1
Lower Grille Pan



Fits 150, 165, 175, 30, 31, 3165

Fits 135, 20, 2135



SHEET METAL

Massey Ferguson

531061M91

Grille, Upper



529672M1

Grille Knob



531060M91

Grille, Lower



529672M1

Grille Knob



Fits 230, 235, 245, 20C

535938M1

Battery Door
8" Long x 13 1/2" Wide



Fits 230 Prior to 9A349239, 245 Prior to 9A349239

772804M91

Battery Door
8 5/8" Long x 13 3/4" Wide



Fits 230 9A349239 And Up, 245 9A349239 And Up, 20C 9A349236 And Up, 30D

531092M91

Side Panel, R/H



531093M91

Side Panel, L/H

Fits 235, 230 Prior to 9A243032

544416M91

Side Panel, R/H



544417M92

Side Panel, L/H

Fits 245, 20C

Massey Ferguson

SHEET METAL

532260M92

Grille, Upper



529672M1

Grille Knob



532234M91

Grille, Lower



529672M1

Grille Knob



Fits 255, 265, 275, 285

578369M1

Rear Side Panel, L/H with Plate



Fits 255, 265, 275, 285

1026697M1

Headlight Rubber Retainer



Fits 35, 50, 65, 135, 150, 165, 175, 180, 230, 235, 245, 255, 265, 275, 202, 203, 204, 205, 302, 304, 20, 2135, 20C, 30B, 40B, 20D, 30E, 40E, 30, 31, 40, 3165

532201M92

Front Side Panel, L/H



532199M92

Front Side Panel, R/H

Fits 255, 265, 275, 285

1027218M1

Headlight Rubber Retainer



Fits 135, 150, 165, 175, 180, 230, 235, 245, 255, 265, 275, 302, 304, 20, 2135, 20C, 30B, 40B, 20D, 30E, 40E, 30, 31, 40, 3165

532220M1

Rear Side Panel, R/H



532221M1 **X**

Rear Side Panel, L/H

Fits 255, 265, 275, 285



SHEET METAL

Massey Ferguson

3614689M91
Replaces 1672659M92
 Hood Assy

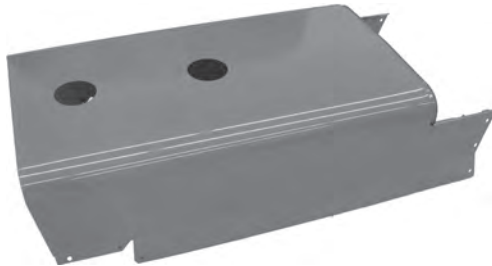

Fits 240, 250

1672823M1
 Hood Moulding



Fits 240, 250, 253, 263, 20D, 20E, 20F, 30E, 30H, 40E

1893487M92
 Battery Door



Fits 240, 250, 20D, 20F, 250, 30E, 40E

3701928M1
 Grille



Fits 231, 240, 253, 261, 254-4, 274-4, 294-4, 20D, 20E

1672786M2
 Side Panel, R/H

1672787M2
 Side Panel, L/H



Fits 240, 250, 30E, 20D, 20F, 30H

1682961M91
 Grille Housing



Fits 240, 250, 20E

1672928M4
Replaces 1672928M1,
1672928M2
 Foot Rest, L/H



1860939M2
Replaces 1860939M1
 Foot Rest, R/H



Fits 240, 250, 20D, 20F, 30E, 40E

1672766M91
 Head Light Assy, L/H Without Bulb

1672768M91
 Head Light Assy, R/H Without Bulb



1876205M1
 Head Light Seal



Fits 240, 250, 253, 263, 20E, 30E, 50E, 50H



Massey Ferguson

SHEET METAL

1883356M92

Shell Fender
With Bracket



Fits TO20, TO30, 35, 50, 65, 35, 50, 20, 2135, 230, 235, 245, 202, 203, 204, 205, 20, 2135, 20C, 30B, 40B

530967M93

Fender, L/H With Single
Headlight Bucket



530966M92

Fender, R/H With Single
Headlight Bucket

Fits 235, 245, 255, 265, 275, 285, 30, 31

1884286M97

Replaces 1693057M91,
1690373M93
Fender, R/H



1884287M97

Replaces 1693058M91,
1690374M94
Fender, L/H

Fits 20D, 20F, 231, 240, 240S, 250, 253, 263, 270, 290, 298, 30E, 30E , 50E

191929M91

Running Board, R/H
With Brackets



180717M91

Running Board, L/H
With Brackets

Fits 35, 50, 202, 203, 204, 205

579237M1

Fender Riser Panel



Fits 235, 245, 255, 265, 275, 285, 30, 31

181627M91

Grille



Fits TO20, TO30

522390M91

Fender, R/H With Dual
Headlight Bucket



526912M91

Fender, L/H With Dual
Headlight Bucket

Fits 135, 150, 165, 175, 180, 30

191383M91

Grille



Fits 35 Up to S/N 231863



SHEET METAL & SEATS

Massey Ferguson

1672995M91

Running Board, L/H



880336M5

Running Board, R/H



Fits 240, 250

181313M93

Seat Pan



Fits TO20, TO30, 35, 50, 65, 135, 150, 165, 175, 230, 235, 245, 255, 202, 203, 204, 205, Super 90, 25, 130, 2200, 20, 30, 40, 50, 2135, 3165, 20C, 30B, 40B, 50C, 20D, 30D, 20D, 30E

508469M2

Rear Step Bracket, R/H



508470M2

Rear Step Bracket, L/H

Fits 135, 2135, 20, 230, 235

1883238M91

Replaces MF8B

Seat Back Cushion



1884538M91

Replaces MF8

Seat Cushion



1662749M91

Tool Box
16 1/2" Long



1662748M91

Tool Box
11 1/2" Long



Fits all MF Tractors

Fits TO20, TO30, 35, 50, 65, 135, 150, 165, 175, 230, 235, 245, 255, 202, 203, 204, 205, Super 90, 25, 130, 2200, 20, 30, 40, 50, 2135, 3165, 20C, 30B, 40B, 50C, 20D, 30D, 20D, 30E

PA-11

Black Seat
With Slide Track



512548M91

Battery Door



Fits 50, 65, 150, 165, 175, 3165, 30, 31

BT-116B

Black Seat
With Slide Track
Without Arm Rests



1884057M94

Battery Cover



Fits 135 UK

Fits Most MF Tractors



Massey Ferguson

WHEELS & RIMS

WHEEL01

Replaces 195638M81,
506020M91, 535448M91,
885741M3, 1883335M2
Front Wheel, 4.5" x 16"
For a 6.00" x 16" Tire



WHEEL02

Replaces 520927M91,
1691618M91, 1678319M91,
Front Wheel, 5.5" x 16"
For a 7.50" x 16" Tire



Fits TO20, TO30, TO35, 35, 50, 65, 135, 150, 165, 175,
180, 230, 235, 245, 1080, 1085, 255, 265, 275, 285, 231,
240, 250, 253, 360, 362, 270, 282, 283, 290, 298, 375,
383, 390, 390T, 398, 399, 670, 690, 698, 699, 202, 203,
204, 205, 302, 304, 20, 2135, 20C, 30B, 40B, 20D, 30E,
40E, 30, 31, 40, 3165

WHEEL03

Replaces 180863M91
Rear Rim, 10" x 28"
6 Loop

WHEEL04

Replaces 194482M91,
535450M91,
1861894M91
Rear Rim, 11" x 28"
6 Loop



WHEEL05

Replaces
Rear Rim, 12" x 28"
6 Loop

WHEEL19

Replaces 1861894M91, 373508R91, AL2452,
AL36059, AL36059, AL63463
Rear Rim, 13" x 28"
6 Loop

Fits TO20, TO30, TO35, 35, 50, 65, 135, 150, 165, 175,
180, 230, 235, 245, 1080, 1085, 255, 265, 275, 285, 231,
240, 250, 253, 360, 362, 270, 282, 283, 290, 298, 375,
383, 390, 390T, 398, 399, 670, 690, 698, 699, 202, 203,
204, 205, 302, 304, 20, 2135, 20C, 30B, 40B, 20D, 30E,
40E, 30, 31, 40, 3165

WEIGHT01

Front Wheel Weight



Fits Most 16" Front Rims

WHEELS & RIMS

Massey Ferguson

WHEEL29

Rear Wheel Center
For 28" Rim
Will also work on 30"
Rims with Drop Center

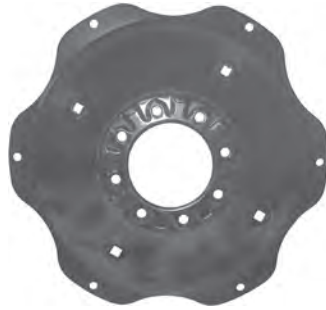

Fits 65, 150, 165, 175, 180, 245, 255, 265, 275, 285, 231, 240, 250, 270, 271

WHEEL33

Replaces 3815965M91
Rear Rim, 15" x 30"
For Square Type
Wheel Center



WHEEL35

Replaces 3815971M1
Rear Wheel Center, 30"
For Square Type Wheel

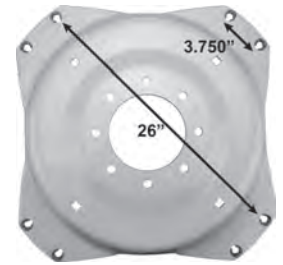

Fits 240, 250, 263, 283, 360, 362, 365, 375, 390, 390T, 393, 394S, 396, 398, 399

WHEEL23

Replaces 1678716M91
Rear Rim, 14" x 30"
8 loop



WHEEL27

Replaces 1678718M1
Rear Wheel Center



Fits 65, 150, 165, 175, 180, 245, 255, 265, 275, 285, 231, 240, 250, 270, 271, 263, 283, 360, 362, 365, 375, 390, 390T, 393, 394S, 396, 398, 399

BOLTKIT01

Bolt & Nut, Fiat Style
2 1/2" Long



BOLTKIT02

Bolt & Nut, MF Style
3" Long



BOLTKIT03

Bolt & Nut, Ford Style
3" Long



BOLTKIT04

Bolt & Nut, JD Style
4 3/4" Long





Massey Ferguson

SHOP MANUALS



ITFE2

I&T FE-2 Ferguson Shop Manual

Fits TE-20, TO-20, TO-30



ITMH2

I&T MH-2 Massey Ferguson Shop Manual

Fits 20, 22, 30, 44 (4-Cylinder Diesel and Non-Diesel), 44 (6-Cylinder, Non-Diesel), 55 (S/N Up to 10,000), 55 Diesel, 81, 82, 101, 101 Super, 102 JR, 102 SR, 201, 202, 203, Pony



ITMH5A

I&T MH-5A Massey Ferguson Shop Manual

Fits Colt Mustang 33, 44, 55, 555



ITMF10

I&T MF-10 Massey Ferguson Shop Manual

Fits MF303, MFH303, MH333, MF404, MHF404, MF406, MH444, MF1001



ITMF14

I&T MF-14 Massey Ferguson Shop Manual

Fits TO35, TO35 Diesel, F40, MH50, MHF202, MF35, MF35 Diesel, MF50, MF202, MF204



ITMF25

I&T MF-25 Massey Ferguson Shop Manual

Fits MF25, MF130



ITMF27

I&T MF-27 Massey Ferguson Shop Manual

Fits MF135 Special, MF135 Deluxe, MF150, MF165; Diesel Models: MF135 Deluxe, MF150, MF165



ITMF36

I&T MF-36 Massey Ferguson Shop Manual

Fits MF285



ITMF41

I&T MF-41 Massey Ferguson Shop Manual

Fits MF670, MF690, MF698



ITMF42

I&T MF-42 Massey Ferguson Shop Manual

Fits Gas Models: MF230, MF235, MF245; Diesel Models: MF230, MF235, MF240, MF245, MF250



ITMF43

I&T MF-43 Massey Ferguson Shop Manual

Fits Diesel Models: MF255, MF265, MF270, MF275, MF290; Gas Models: MF255, MF265



ITMF44

I&T MF-44 Massey Ferguson Shop Manual

Fits MF3505, MF3525, MF3545



ITMF45

I&T MF-45 Massey Ferguson Shop Manual

Fits MF362, MF365, MF375, MF383, MF390, MF390T, MF398



ITMF46

I&T MF-46 Massey Ferguson Shop Manual

Fits Diesel Models: MF340, MF350, MF355, MF360, MF399



ITMF47

I&T MF-47 Massey Ferguson Shop Manual

Fits MF1010, MF1020



ITMF201

I&T MF-201 Massey Ferguson Shop Manual

Fits Gas Models: MF65, MF85, MF88, MF Super 90, MF Super 90WR, MF1100; Diesel Models: MF65, MF85, MF88, MF Super 90, MF Super 90WR, MF1080, MF1085, MF1100, MF1105, MF1130, MF1135, MF1150, MF1155



ITMF202

I&T MF-202 Massey Ferguson Shop Manual

Fits Gas Models: MF175, MF180; Diesel Models: MF175, MF180, MF205, MF210, MF220, MF2675, MF2705, MF2745, MF2775, MF2805

